



Baumer

Passion for Sensors

Capacitive sensors

Non-contact detection of liquid and solid objects



Partnership.
Precise.
Pioneering.

Visibly better: Baumer sensors.

The Baumer Group is leading at international level in the development and production of sensors, shaft encoders, measuring instruments as well as components for automatic image processing. As an owner-managed family business, we employ about 2400 workers worldwide in 38 subsidiaries and 19 countries. With marked customer orientation, consistently high quality and vast innovation capability, Baumer develops specific solutions for many industries and applications worldwide.

Our standards – your benefits.

- Passion coupled with expertise – both have made us a sensor pioneer and technology leader
- Our range of services is hard to beat – we have the right product, developed by our own team, for every task
- Inspiring through innovation – a challenge Baumer employees take on every day
- Reliability, precision and quality – our customers' requirements are what drives us
- Partnership from the start – together with our customers we develop suitable solutions
- Always a step ahead – thanks to our production depth, our flexibility and our delivery reliability
- Available worldwide – Baumer is Baumer everywhere



Innovative all-rounders.

Capacitive sensors can detect metallic, non-metallic, transparent, opaque, liquid and solid substances reliably without the need for contact. These properties make them true «all-rounders», which are used in a many different industrial applications. The ability of the measuring field to penetrate non-conductive materials is particularly advantageous for measuring filling levels. Capacitive sensors can be installed outside of a container to detect a filling level inside. This protects the sensor from aggressive media and prevents contamination of high-quality materials by the sensor at the same time.

Years of production and development know-how and our proximity to the market, allow us to offer our standard portfolio but also to develop application-optimized solutions and innovations as well as unique mounting concepts.



Learn more.

Downloadable data sheets as well as further information about our products is available at:

www.baumer.com/capacitive



Table of contents.

Introduction

Electrical and mechanical definitions	6
Definition of sensing distance	7
Protection classes	8
Installation and mounting procedure	9
Connection diagrams	10
Design and function	12
Detectable media	13
Sensor selection	14

Capacitive sensors

Overview	18
Cylindrical designs	20
Rectangular designs	33

Accessories

Connectors	42
Connectors/Pin assignment	46
Connectors/Housing types	47
Divers	48
Mounting kits Sensofix	50
Mounting accessories CFDK 25	52

Index

Index Capacitive sensors	53
--------------------------	----

Material-independent object and filling level detection – capacitive sensors.



Contactless

- Reliable object detection with sensing distances up to 30 mm
- No sensor damage due to aggressive media
- Medium is not contaminated by the sensor



No matter what material

- Reliable of detection of conductive and non-conductive materials
- Failure-free detection of highly transparent and opaque materials
- Reliable detection even on optically reflecting surface



Durable

- Protected installation outside the container possible
- Closed sensor front increases lifetime in case of contact with liquids
- High wear resistance of the housing increases sensor lifetime in case of contact with granules

Applications

- Machine tools
- Graphic machinery
- Packaging machinery
- Food and beverages
- Installation/handling
- Medical devices
- Laboratory automation

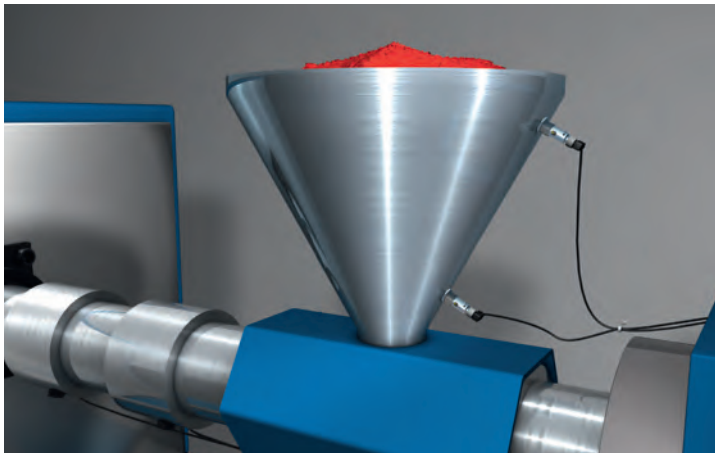

Granule level detection in injection molding plants

- Robust design protects the sensors from mechanical wear
- Surface-independent detection
- Fast and easy installation

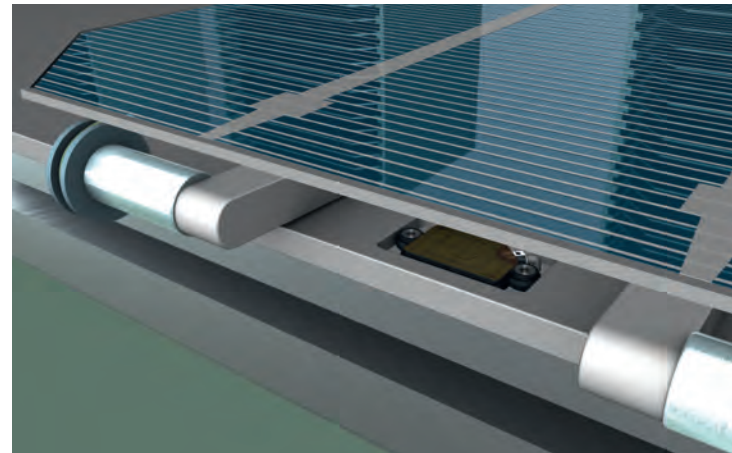

Wafer detection in solar cell manufacturing facilities

- Reliable wafer detection thanks to large sensing distances
- Flush mounting possible thanks to flat design
- Detection regardless of transparency and brightness of the objects

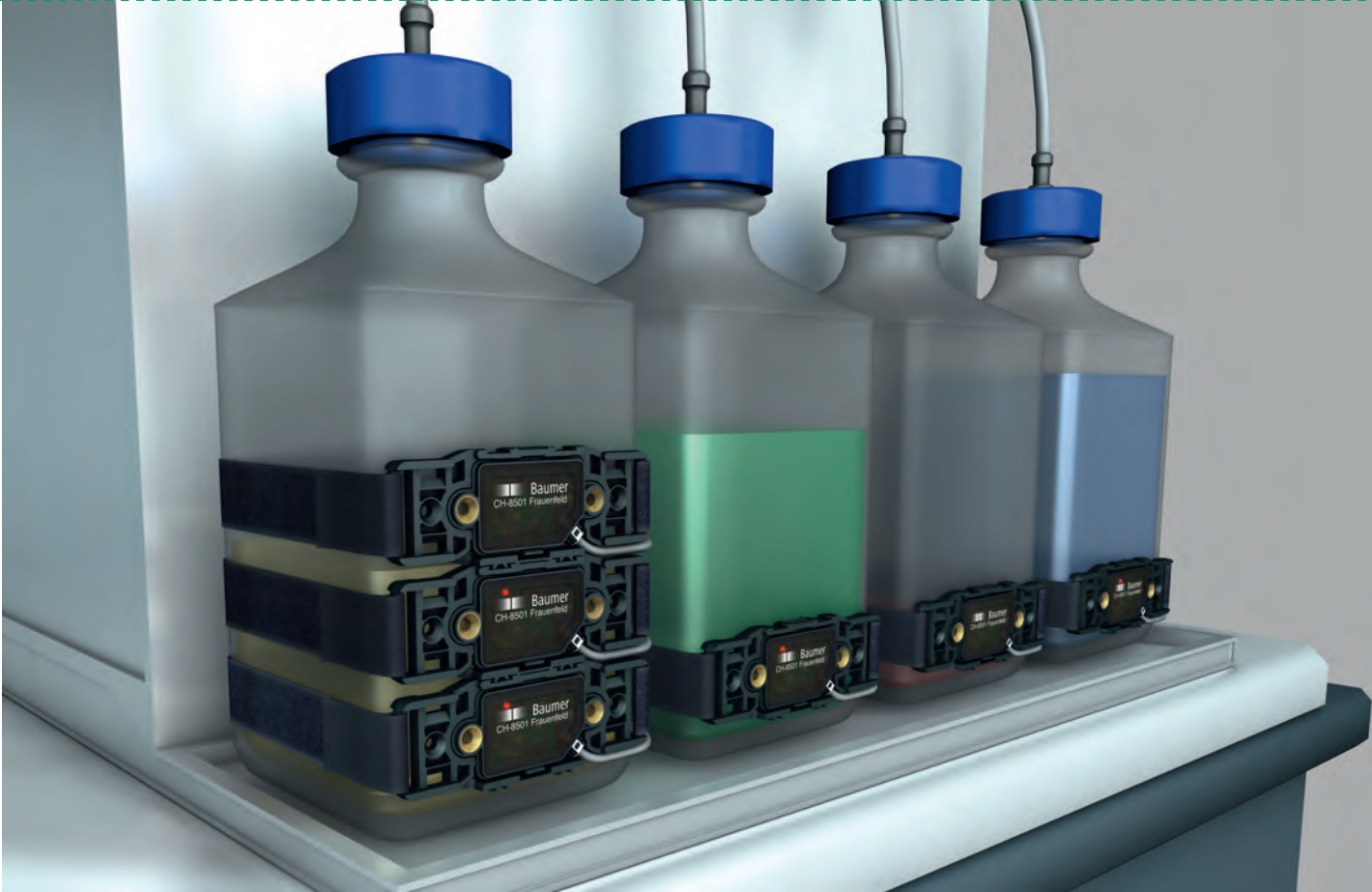

Liquid level monitoring of return flow tanks in laboratory automation

- Fast and easy sensor installation outside the tanks
- Long lifetime thanks to robust housing
- Several self-definable monitoring areas thanks to easy cascading

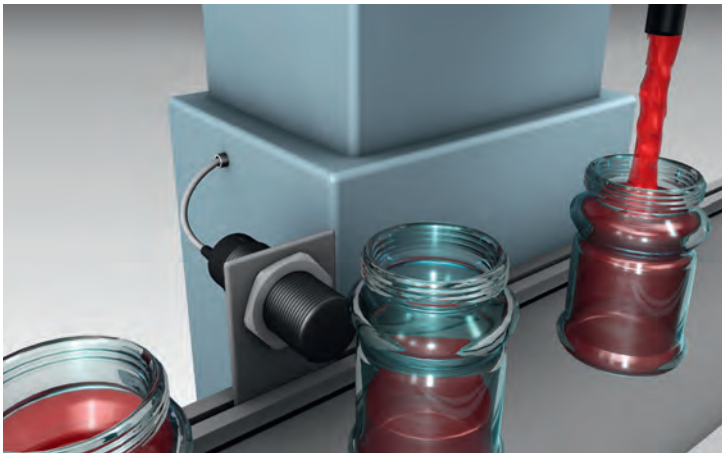

Filling level monitoring in bottling plants

- Detection through packaging
- Quality control of closed packaging at the end of the process possible
- Color-independent detection increases process safety

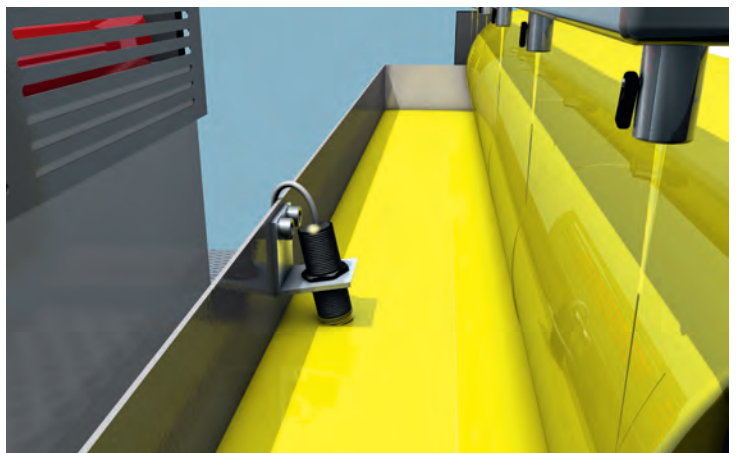

Ink level detection in offset printing machines

- Level detection in direct contact with the liquid
- Dirt and drop retention is suppressed by the sensor
- Easy and safe functional principle



■ A

Admissible lead lengths

For proximity switches large lead lengths signify load capacitance of the output and increased influence of interference signals. Lead lengths >5 m should, if possible, be avoided.

■ C

Connection cable

Most capacitive sensors come standard with a highly flexible PVC cable. If higher resistance to grease and oil is required, they can also be supplied with a PUR cable. The standard cable length is 2 m.

Current consumption

Current maximally consumed by the circuit at nominal voltage (no load).

■ D

Dimension

This specification usually refers to the diameter of the sensing face. The following applies: the larger the sensing face, the greater the sensing distance (S_n).

■ E

Electrical conductivity

Electrical conductivity is the ability of a medium to conduct an electrical current. It is specified in Siemens per meter.

■ H

Hysteresis

Hysteresis is the difference between the operating and switching-off point as an object approaches and moves away from the sensor.

■ O

Output indicator

The LED indicates the current output.

Oil resistance

Sensors with all-metal housing and PUR cable are suitable for applications in oily environments.

Output protection

The sensors are protected against voltage peaks, short circuits and reverse polarity.

■ R

Residual ripple

It is assumed for sensor operation that the specified voltage supply range is not exceeded or under-shot at any time. A residual ripple VR of max. 10% of the direct current average value is tolerated by the sensor within these limits.

Repeat accuracy

Repeat accuracy is the maximum deviation of the sensing distance during 2 arbitrary measurements within 8 hours under constant conditions.

Reverse polarity protection

The sensors are protected against voltage peaks, short circuits and reverse polarity.

■ S

Sensing face

The size of the sensing face is defined by the electrodes. The larger the measuring electrode, the larger the electrical field and the greater the sensing distance.

Sensor standard

The sensor standard is described in EN 60947-5-2:2007.

Short circuit protection

The sensors are protected against voltage peaks, short circuits and reverse polarity.

Load current

Specifies the maximum current that may flow through the output for an unlimited period.

Switching frequency

The highest possible number of switching operations per second is defined in the sensor standard EN 60947.

■ T

Temperature drift

Within the specified temperature range, the effective sensing distance S_r can change in relation to the nominal sensing distance S_n by the specified range.

Operating temperature range

The sensors are designed and tested for function in the specified temperature range.

■ V

Voltage drop Vd

This specification indicates the maximally dropping voltage via the controlled output.

Voltage supply range +VS

At a maximum residual ripple of 10%, the voltage supply must not exceed and/or fall below the specified minimum and maximum values.



Sensing distance

The international standard EN 60947-5-2 defines sensing distance as follows: sensing distance is the distance at which a standard target moving toward the sensing face of a proximity switch causes a signal change.

The sensing distance of capacitive sensors depends on the following factors

- Sensor diameter
- Sensor design (with/without GND electrode)
- Material of the medium to be detected
- Size of the approached body

Standard target

Predefined part used for comparative measurement of sensing distances and scanning ranges. The standard target is square, 1 mm thick and made of Fe 360 (ST 37). The side length corresponds to either the diameter of the sensing face or the triple nominal sensing distance S_n , the respectively higher value being definitive. The target must be grounded.

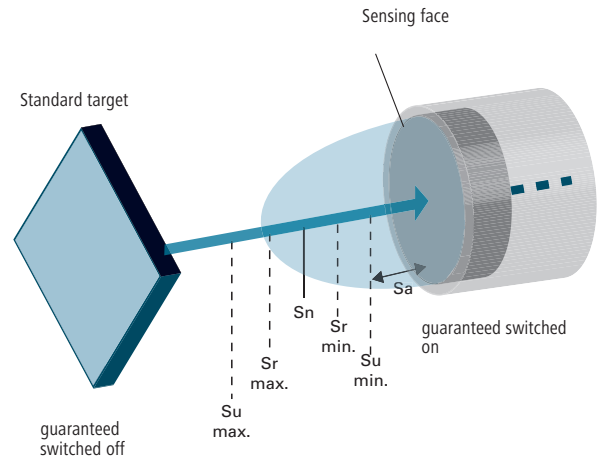

Nominal sensing distance S_n

Nominal sensing distance S_n is a type classification parameter and does not take into account tolerances during machining or changes due to external conditions such as voltage or temperature.

Usable sensing distance S_u

Sensing distance of an individual proximity switch measured over the temperature range and at a supply voltage of 85% and 110% of the rated value. For capacitive proximity switches it must be between 80% and 120% of the effective sensing distance.

Effective sensing distance S_r

Effective sensing distance of an individual proximity switch which is measured at a defined temperature, voltage and installation conditions. For capacitive proximity switches it must be between 90% and 110% of the nominal sensing distance at $23 \pm 5 \text{ }^\circ\text{C}$

Assured sensing distance S_a

Distance from the sensing face at which the operation of the proximity switch is ensured under defined conditions. For capacitive proximity switches the assured sensing distance is between 0% and 72% of the nominal switching distance.



Protection classes



- 1) Protection from ingress of dust and complete protection against electric shock.
- 2) Protection from water jets from any direction.



IP 67 includes the IP 65 specification. In addition this class offers protection against water when the housing is immersed in water under defined pressure and time conditions (30 minutes in 1 meter deep water).



Water must not enter in a quantity that will produce harmful effects if the housing is continuously immersed in water and if conditions which are specified between the manufacturer and user are fulfilled. The conditions must however be more difficult than in IP 67.



Protection from ingress of water during high-pressure cleaning with pure water at a water pressure of 8,000 bis 10,000 kPa and a water temperature of +80 °C. The pressurization period is 30 seconds per position. Because this test procedure distinctly differs from the other IP tests, devices with the test seal IP 69K do not automatically have protection class IP 67 or IP 68. Solely devices with protection class IP 67 also have the underlying protection classes as well.

Installation and mounting procedure



To rule out unintentional interference of the measuring field and to achieve maximum sensing distances, it is required to follow the mounting instructions and to maintain the specified minimum distances. If the minimum distances are undercut, a reduction of the sensing distances is expectable. A sensor test directly at the application is recommended.

Mounting arrangement Flush mounting procedure

Flush mounting of flush-mountable capacitive sensors is possible in all materials. The minimum distance between the sensors must be observed.

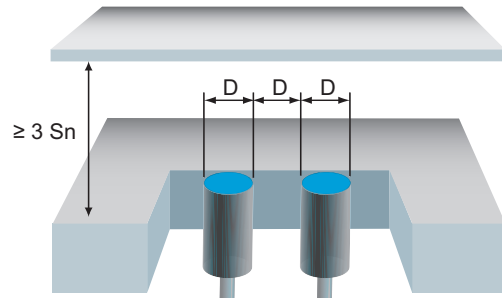

Mounting arrangement Non-flush mounting procedure

For non-flush-mountable capacitive sensors a free zone must be created around the sensor head which must not contain any damping material.

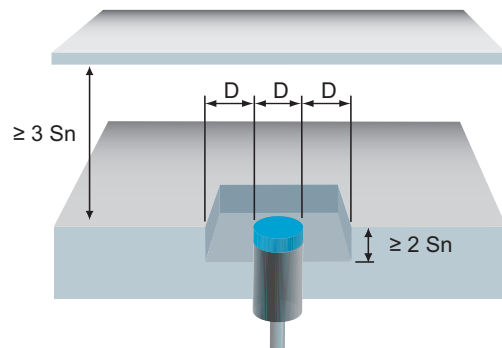

Max. installation torques

To avoid damage during sensor installation, the specified installation torques must not be exceeded.

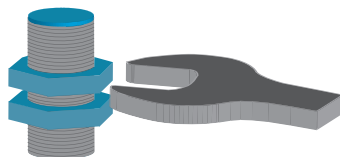

Cylindrical housing with external thread

	Brass	nickel-plated	Plastic
M12	15 Nm		1,5 Nm
M18	40 Nm		3,0 Nm
M30	200 Nm		15 Nm

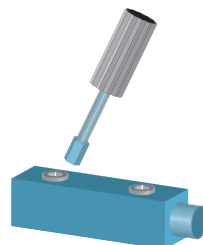

Rectangular housing

	Brass	nickel-plated	Plastic
M3	0,9 Nm		0,5 Nm
M4	2,1 Nm		1,0 Nm



Explanatory notes on the connection diagrams

The specified diagrams indicate the undamped output. A sensor is in a damped state when an object is located in within its scanning range. In the diagrams Z denotes the typical load resistance position; U_z denotes the voltage applied to this load resistance. If $U_z = \text{high}$ ($\approx +V_s$), then current flows; if $U_z = \text{low}$ ($\approx 0 \text{ V}$), then no current flows via the load resistance. Load resistance between output and $+V_s$ is referred to as pull-up resistance, load resistance between output and 0 V as pull-down resistance.

PNP or NPN output

Sensors with a PNP or NPN output have a 3-wire design ($+V_s$, output and 0 V) and operate with direct current (DC). The load resistance of PNP sensors is between output and 0 V (pull-down resistance), while load resistance of NPN sensors is between $+V_s$ and output (pull-up resistance). As a result, the PNP output is connected to the positive voltage supply during switching (positive switching output), whereas the NPN output is connected to the negative voltage supply during switching (negative switching output).

Normally open contacts and/or normally closed contacts define the switching function. Normally open contacts are referred to as normally open (NO), normally closed contacts as normally closed (NC). During damping with an object, sensors with normally open function establish contact connections ($U_z = \text{high}$), while sensors with normally closed function disconnect connections ($U_z = \text{low}$).

PNP normally open (NO)

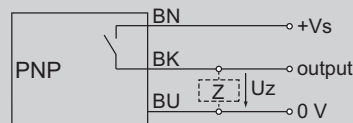

State	U_z	LED
undamped	low	off
damped	high	on

PNP normally closed (NC)

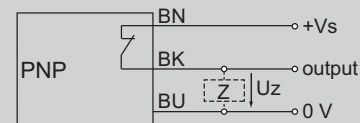

State	U_z	LED
undamped	high	on
damped	low	off

NPN normally open (NO)

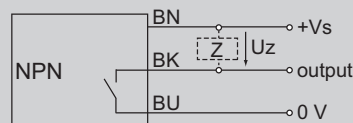

State	U_z	LED
undamped	low	off
damped	high	on

NPN normally closed (NC)

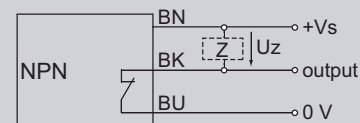

State	U_z	LED
undamped	high	on
damped	low	off



Push-pull output (push-pull)

Sensors with a push-pull output have a 3-wire design like PNP or NPN sensors (+Vs, output and 0 V) and also operate with direct current (DC). Because this output is designed as a change-over, it can be used as a positive or as a negative switching output depending on the wiring. Therefore it is compatible with PNP or NPN outputs and is universally usable. If the load is connected to 0 V, the behavior of the output potential is identical to that of a sensor with a PNP output; when the load is connected to +Vs, the behavior of the the output potential is identical to that of a sensor with an NPN output. The switching function active low means that during damping with an object approx. 0 V (low) are over the load resistance; at active high approx. +Vs (high) are over the load resistance during damping. Parallel connection of push-pull sensors is possible only with corresponding wiring.

Push-pull active high

State	Uz1	Uz2	LED
undamped	low	high	off
damped	high	low	on

Push-pull active low

State	Uz1	Uz2	LED
undamped	high	low	on
damped	low	high	off

Compatibility of push-pull and PNP/NPN

PNP normally open (NO)	push-pull active high with pull-down load
PNP normally closed (NC)	push-pull active low with pull-down load
NPN normally closed (NC)	push-pull active high with pull-up load
NPN normally open (NO)	push-pull active low with pull-up load



Function

The capacitive sensor basically functions like an open capacitor. An electrical field is formed between the measuring electrode and the GND electrode. If a material with a dielectric constant ϵ_r greater than air enters the electrical field, the capacity of the field increases depending on the ϵ_r of this material. The electronics measure this capacity increase, the generated signal is conditioned during subsequent signal processing and causes output switching at a corresponding magnitude.

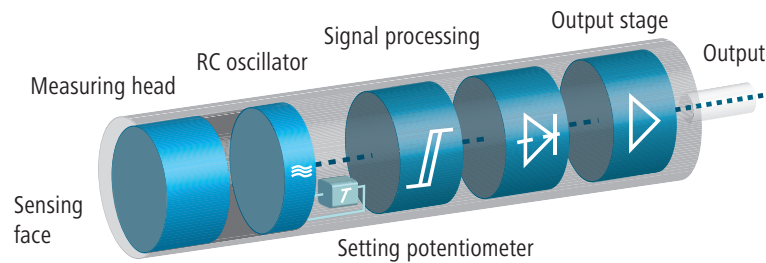

Sensor type

Sensors with GND electrode

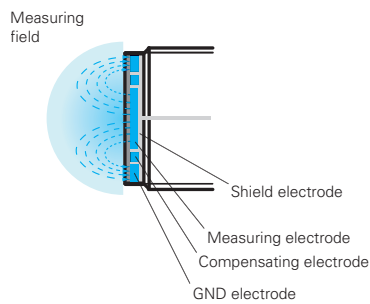

These sensors can be flush-mounted with the sensing face in a material. Because the measuring field of these sensors extends from the measuring to the integrated GND electrode, a defined measuring field is created. They are particularly suitable for detecting non-conductive materials such as oils, glass, wood or plastics, but can also detect conductive materials just as well. To prevent undesired switching and moisture on the sensor surface, a compensating electrode was integrated to suppress undesired objects

Sensors without a GND electrode

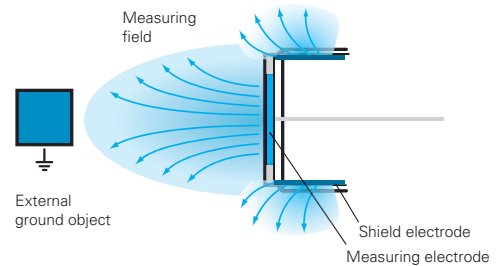

Generally these sensors cannot be flush mounted. Since they do not have a GND electrode, the object to be detected performs the function of a GND electrode. Sensors without a GND electrode feature low sensitivity to soiling and condensation and are suitable especially for level tasks. To achieve long sensing distances, the medium to be detected should be conductive and optimally grounded.



Dielectric constant

Capacitive sensors detect conductive as well as non-conductive media with a dielectric constant $\epsilon_r > 1$. The dielectric constant ϵ_r (also relative permittivity or inductive capacitance) of a material indicates how many times greater the electric flux density will become if instead of vacuum (air) the corresponding material enters the measuring field.

Conductive media

Conductive media typically has an electrical conductivity $> 20 \mu\text{S/cm}$. Conductive material can easily be detected by all sensor types whether they have a GND electrode or not. In conductive media the dielectric constant is irrelevant for the sensing distance. The sensing distance is influenced by the size of the object and its grounding.

- Conductive media include:
- Water
 - Blood
 - Ink
 - Milk
 - Acetone
 - Metals

Non-conductive media

Non-conductive media typically has an electrical conductivity $< 20 \mu\text{S/cm}$. In general sensors with a GND electrode are recommended for non-conductive media. If a non-conductive object is moved into the sensor field, the field increases depending on the dielectric constant and the size of the material to be detected, increasing the capacity of the measuring field. The lower ϵ_r is, the harder it is to detect the medium. Generally it can be said that e.g. for plastics with $\epsilon_r = 3$ the effective sensing distance S_r corresponds to approximately 50% of the nominal sensing distance S_n .

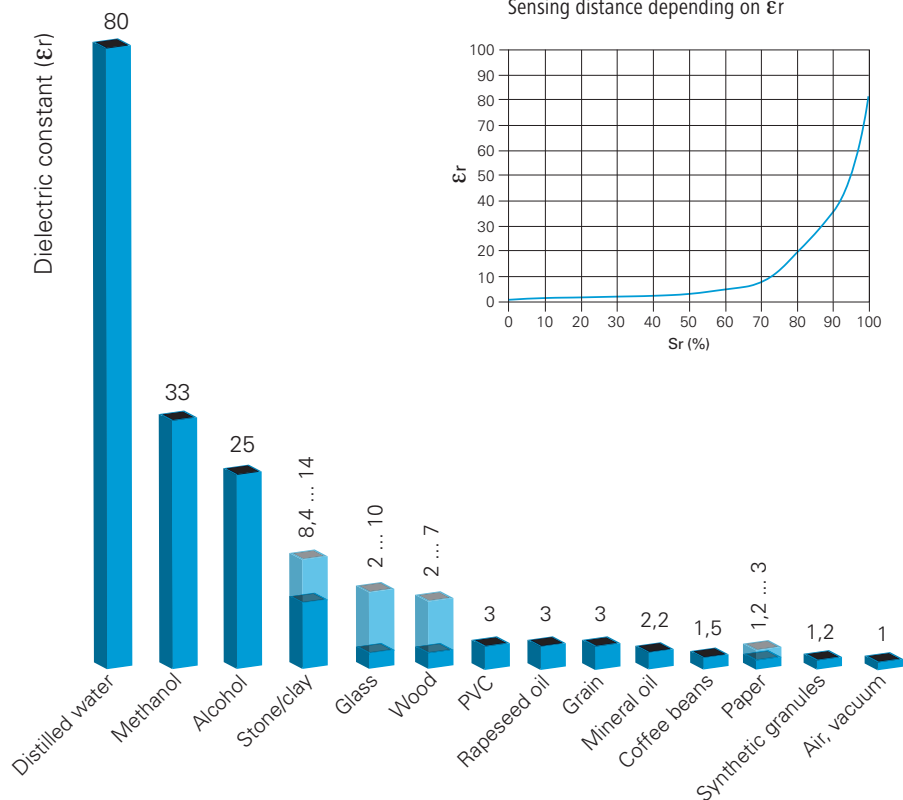



To facilitate the selection of the right capacitive sensor, this double page provides an initial overview of suitable sensors based on the task and type of medium to be detected

Task



Level detection in direct contact

Capacitive sensors in especially robust plastic and metal housings are very suitable for level detection in direct contact with the medium. The sensors feature high chemical and mechanical resistance. They are installed through an opening in the container wall or inside the container. The internal compensating electrode prevents switching errors caused by sediments and moisture on the sensing face. Sensors with a fully enclosed housing are preferable for applications with direct media contact.

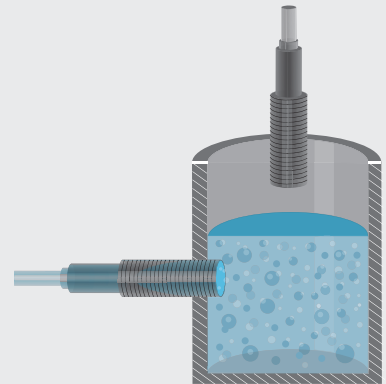

Level detection through container walls

Capacitive sensors can detect media through non-conductive container walls without any problems. This is a big benefit particularly in closed containers, chemically aggressive media or in media which must not be contaminated. The higher the dielectric constant or conductivity of the medium to be detected, the better it can be detected by the sensor through the container wall.

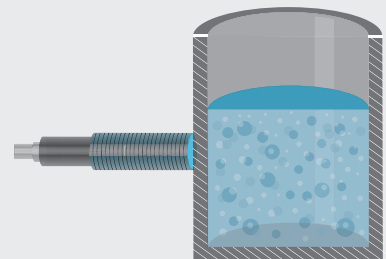

Object detection / bulk goods

Capacitive sensors can detect all kinds of objects without any problems. The better the level of conductivity and grounding of an object is, the higher is the level of signal reserves and detection reliability. Because many capacitive sensors can be flush mounted, they are suitable for protected, space-saving installation

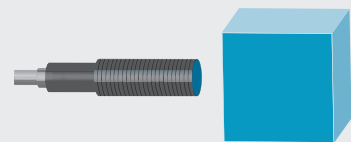

Suitable sensors (selection)

Conductive medium



CFAK 12
(Sn = 0,5 mm)



CFAK 18
(Sn = 5 mm)



CFAK 18
(Sn = 15 mm)



CFDK 25
(Sn = 4 mm)



CFAK 18
(Sn = 15 mm)



CFAK 30
(Sn = 30 mm)



CFDK 25
(Sn = 8 mm)



CFAK 18
(Sn = 15 mm)



CFAK 30
(Sn = 30 mm)

Non-conductive medium



CFAK 18
(Sn = 15 mm)



CFAK 30
(Sn = 8 mm)



CFAK 30
(Sn = 30 mm)



CFDK 25
(Sn = 8 mm)



CFAM 18
(Sn = 8 mm)



CFAM 30
(Sn = 15 mm)



CFDK 25
(Sn = 15 mm)



CFAM 12
(Sn = 4 mm)



CFAM 18
(Sn = 8 mm)

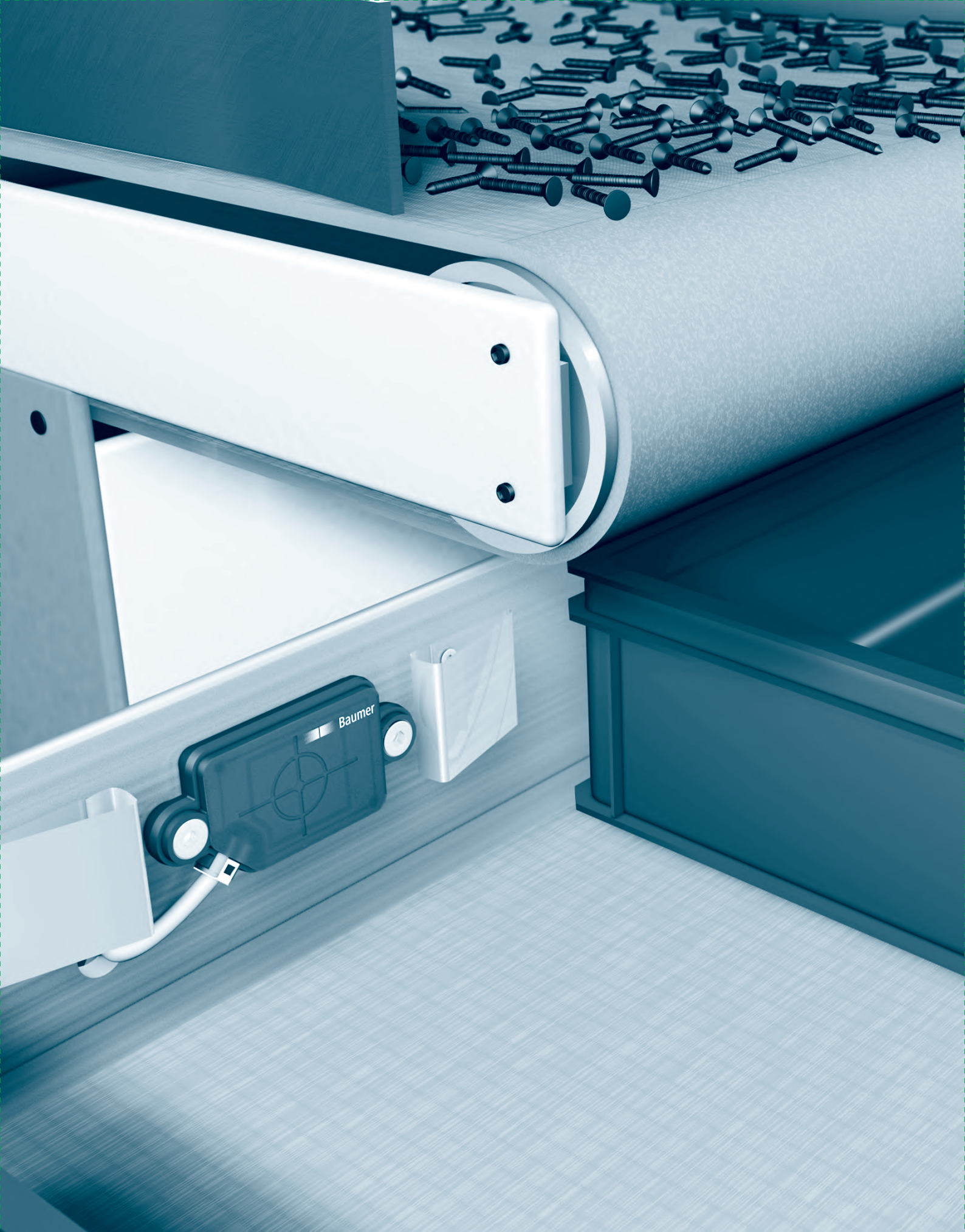









Capacitive sensors





Overview	Page 18
Cylindrical designs	Page 20
Rectangular designs	Page 33
Accessories	Page 41

cylindrical designs

product family	CFAK 12	CFAK 12	CFAM 12	CFAK 18	CFAK 18	CFAM 18	CFBM 20
							
nominal sensing distance Sn	0,1 mm	0,5 mm	4 mm	5 mm	15 mm	8 mm	10 mm
mounting type	non-flush	non-flush	flush	non-flush	non-flush	flush	flush
GND electrode	no	no	yes	no	no	yes	yes
dimension	12 mm	12 mm	12 mm	18 mm	18 mm	18 mm	20 mm
housing material	POM	PBT	brass nickel plated	PBT	PBT	brass nickel plated	brass nickel plated
sensitivity adjustment	no	no	potentiometer, 240°	no	potentiometer, 12 turn	potentiometer, 12 turn	potentiometer, 18 turn
protection class	IP 67	IP 67	IP 65	IP 67/65 (sensing face/sensor)	IP 67/65 (sensing face/sensor)	IP 65	IP 65
detection of non-conductive media	no	no	yes	yes	yes	yes	yes
fill level detection through container	no	no	yes	yes	yes	yes	yes
liquids in direct contact	yes	yes	no	yes	yes	no	no
object detection / bulk goods	no	no	yes	yes	yes	yes	yes
page	20	22	23	24	25	26	27

rectangular designs

product family	CFDM 20	CFDK 25	CFDK 25	CFDK 25	CFDK 25	CFDK 25	CFDK 30
							
nominal sensing distance Sn	5 mm	2 mm	4 mm	8 mm	12 mm	15 mm	15 mm
mounting type	flush	flush	flush	flush	flush	non-flush	flush
GND electrode	yes	no	no	no	no	no	yes
dimension	20 mm	25 mm	25 mm	25 mm	25 mm	25 mm	30 mm
housing material	brass nickel plated	PA 12	PA 12	PA 12	PA 12	PA 12	PBT
sensitivity adjustment	no	no	no	no	no	no	potentiometer, 15 turn
protection class	IP 65	IP 65	IP 65	IP 65	IP 65	IP 65	IP 65
detection of non-conductive media	yes	no	no	yes	yes	yes	yes
fill level detection through container	yes	yes	yes	yes	no	no	yes
liquids in direct contact	no	no	no	no	no	no	no
object detection / bulk goods	yes	no	no	yes	yes	yes	yes
page	33	34	35	36	37	38	39

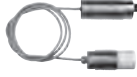
CFAK 22	CFAK 30	CFAK 30	CFAM 30	CFAH 30
				
	8 mm	30 mm	15 mm	15 mm
non-flush	non-flush	non-flush	flush	non-flush
	no	no	yes	no
22 mm	30 mm	30 mm	30 mm	30 mm
PA 10T/X	PBT	PBT	brass nickel plated	V2A/PTFE
	no	potentiometer, 18 turn	potentiometer, 18 turn	potentiometer, 18 turn
IP 69K	IP 67/65 (sensing face/sensor)	IP 67/65 (sensing face/sensor)	IP 65	IP 67
no	yes	yes	yes	yes
no	yes	yes	yes	no
yes	yes	yes	no	yes
no	yes	yes	yes	no
28	29	30	31	32



Sn = 0,1 mm



- Use in soiled, conductive media
- Suppression of dirt and cleaning agents
- For installation in grounded metal containers

general data	
special type	liquid level sensor for wastewater
nominal sensing distance Sn	0,1 mm
mounting type	non-flush
GND electrode	no
temperature drift	± 20 %
sensitivity adjustment	no
output indicator	LED yellow
measurement type	contact with medium

electrical data	
voltage supply range +Vs	10 ... 30 VDC
current consumption max. (no load)	12 mA
output current	< 200 mA
voltage drop Vd	< 2,5 VDC
switching frequency	< 15 Hz
short circuit protection	yes
reverse polarity protection	yes

mechanical data	
type	cylindrical threaded
housing material	POM
material (screw nut)	POM
material (gasket)	EPDM50
dimension	12 mm
housing length	39,5 mm

ambient conditions	
operating temperature	0 ... +50 °C
protection class	IP 67

field of application	
detection of non-conductive media	no
fill level detection through container	no
liquids in direct contact	yes
object detection / bulk goods	no

connectors and mating connectors	
ESG 32SH0200	Connector M8, 3 pin, straight, 2 m
ESW 31SH0200	Connector M8, 3 pin, angular, 2 m
additional cable connectors and field wireable connectors: see accessories	

Accessories	
10161959	Converter PNP/NPN - M8 x 1
11163236	Adapter for pulse stretching M8
for details: see accessories section	

dimension drawings

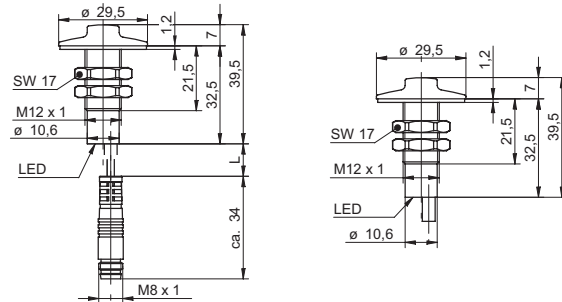

connection diagrams

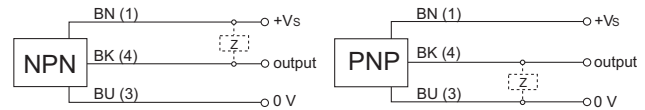

order reference	output circuit	connection types
CFAK 12N1140/KS35L	NPN make function (NO)	flylead connector M8, L=200 mm
CFAK 12N1140/L	NPN make function (NO)	cable, 2 m
CFAK 12N3140/KS35L	NPN break function (NC)	flylead connector M8, L=200 mm
CFAK 12N3140/L	NPN break function (NC)	cable, 2 m
CFAK 12P1140/KS35L	PNP make function (NO)	flylead connector M8, L=200 mm
CFAK 12P1140/L	PNP make function (NO)	cable, 2 m
CFAK 12P3140/KS35L	PNP break function (NC)	flylead connector M8, L=200 mm
CFAK 12P3140/L	PNP break function (NC)	cable, 2 m



Sn = 0,5 mm



- Level control of optimally conductive liquids
- Suitable for direct contact
- Suppression of dirt and drops

general data	
nominal sensing distance Sn	0,5 mm
mounting type	non-flush
GND electrode	no
temperature drift	± 20 %
sensitivity adjustment	no
output indicator	LED yellow
measurement type	contact with medium

electrical data	
voltage supply range +Vs	10 ... 30 VDC
current consumption max. (no load)	12 mA
output current	< 200 mA
voltage drop Vd	< 2,5 VDC
switching frequency	< 15 Hz
short circuit protection	yes
reverse polarity protection	yes

mechanical data	
type	cylindrical threaded
housing material	PBT
dimension	12 mm
housing length	39 mm
connection types	cable, 2 m

ambient conditions	
operating temperature	0 ... +70 °C
protection class	IP 67

field of application	
detection of non-conductive media	no
fill level detection through container	no
liquids in direct contact	yes
object detection / bulk goods	no

Accessories	
10151720	Sensofix series 12 round
for details: see accessories section	

order reference	output circuit
CFAK 12N1103	NPN make function (NO)
CFAK 12N3103	NPN break function (NC)
CFAK 12P1103	PNP make function (NO)
CFAK 12P3103	PNP break function (NC)

dimension drawing

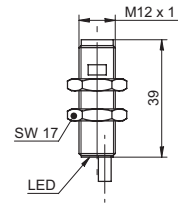

connection diagrams

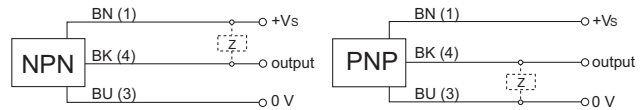

remarks

Other housing materials are available on request



Sn = 4 mm

- Versatile
- Sensitivity adjustment via pot
- Flush mounting possible

general data

nominal sensing distance Sn	4 mm
nominal sensing distance Sn adjustable	0,5 ... 4 mm
mounting type	flush
GND electrode	yes
temperature drift	± 15 % (+10 ... +70 °C)
sensitivity adjustment	potentiometer, 240°
output indicator	LED yellow

electrical data

voltage supply range +Vs	10 ... 30 VDC
current consumption max. (no load)	20 mA
output current	< 200 mA
voltage drop Vd	< 1,5 VDC
switching frequency	< 50 Hz
short circuit protection	yes
reverse polarity protection	yes

mechanical data

type	cylindrical threaded
housing material	brass nickel plated
dimension	12 mm

ambient conditions

operating temperature	-25 ... +75 °C
protection class	IP 65

field of application

detection of non-conductive media	yes
fill level detection through container	yes
liquids in direct contact	no
object detection / bulk goods	yes

connectors and mating connectors

ESG 34SH0200	Connector M12, 3 pin, straight, 2 m
ESW 33SH0200	Connector M12, 3 pin, angular, 2 m

additional cable connectors and field wireable connectors: see accessories

Accessories

10151720	Sensofix series 12 round
10161958	Converter PNP/NPN - M12 x 1
11163237	Adapter for pulse stretching M12

for details: see accessories section

order reference	housing length	output circuit	connection types
CFAM 12N1600	60 mm	NPN make function (NO)	cable, 2 m
CFAM 12N1600/S14	76 mm	NPN make function (NO)	connector M12
CFAM 12N3600	60 mm	NPN break function (NC)	cable, 2 m
CFAM 12N3600/S14	76 mm	NPN break function (NC)	connector M12
CFAM 12P1600	60 mm	PNP make function (NO)	cable, 2 m
CFAM 12P1600/S14	76 mm	PNP make function (NO)	connector M12
CFAM 12P3600	60 mm	PNP break function (NC)	cable, 2 m
CFAM 12P3600/S14	76 mm	PNP break function (NC)	connector M12



dimension drawings

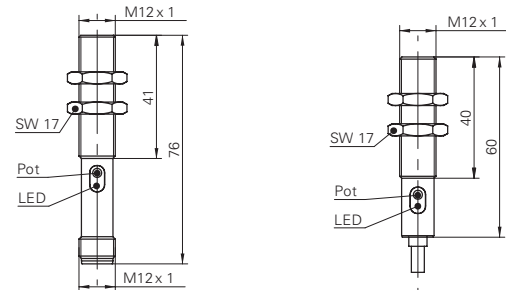

connection diagrams

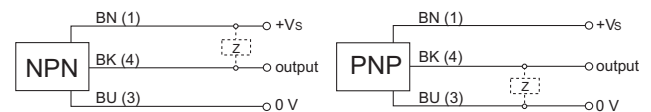



Sn = 5 mm



- Preset sensing distance
- Fully enclosed housing
- Direct contact with liquids possible

general data

nominal sensing distance Sn	5 mm
mounting type	non-flush
GND electrode	no
temperature drift	± 15 % (0 ... +70 °C)
sensitivity adjustment	no
output indicator	LED yellow

electrical data

voltage supply range +Vs	10 ... 30 VDC
current consumption max. (no load)	20 mA
output current	< 200 mA
voltage drop Vd	< 1,5 VDC
switching frequency	< 50 Hz
short circuit protection	yes
reverse polarity protection	yes

mechanical data

type	cylindrical threaded
housing material	PBT
dimension	18 mm
housing length	63,5 mm
connection types	cable, 2 m

ambient conditions

operating temperature	-25 ... +75 °C
protection class	IP 67/65 (sensing face/sensor)

field of application

detection of non-conductive media	yes
fill level detection through container	yes
liquids in direct contact	yes
object detection / bulk goods	yes

Accessories

10151658	Sensofix series 18
for details: see accessories section	

order reference **output circuit**

CFAK 18N1100	NPN make function (NO)
CFAK 18N3100	NPN break function (NC)
CFAK 18P1100	PNP make function (NO)
CFAK 18P3100	PNP break function (NC)

dimension drawing

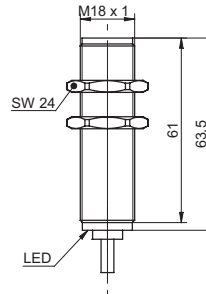

connection diagrams

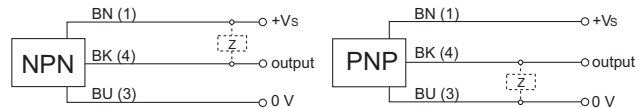



Sn = 15 mm

- Sensitivity adjustment via pot
- Fully enclosed housing
- Direct contact with liquids possible



general data

nominal sensing distance Sn	15 mm
nominal sensing distance Sn adjustable	2 ... 15 mm
mounting type	non-flush
GND electrode	no
temperature drift	± 15 % (+10 ... +70 °C)
sensitivity adjustment	potentiometer, 12 turn
output indicator	LED yellow

electrical data

voltage supply range +Vs	10 ... 30 VDC
current consumption max. (no load)	20 mA
output current	< 200 mA
voltage drop Vd	< 1,5 VDC
switching frequency	< 50 Hz
short circuit protection	yes
reverse polarity protection	yes

mechanical data

type	cylindrical threaded
housing material	PBT
dimension	18 mm
housing length	63,5 mm
connection types	cable, 2 m

ambient conditions

operating temperature	-25 ... +75 °C
protection class	IP 67/65 (sensing face/sensor)

field of application

detection of non-conductive media	yes
fill level detection through container	yes
liquids in direct contact	yes
object detection / bulk goods	yes

Accessories

10151658	Sensofix series 18
for details: see accessories section	

order reference output circuit

CFAK 18N1200	NPN make function (NO)
CFAK 18N3200	NPN break function (NC)
CFAK 18P1200	PNP make function (NO)
CFAK 18P3200	PNP break function (NC)

dimension drawing

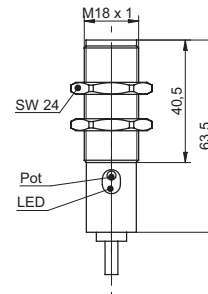

connection diagrams

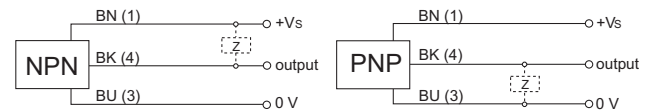

CFAK 18 Sn = 15 mm

Capacitive proximity sensors



Sn = 8 mm

- Versatile
- Sensitivity adjustment via pot
- Flush mounting possible



general data

nominal sensing distance Sn	8 mm
nominal sensing distance Sn adjustable	2 ... 8 mm
mounting type	flush
GND electrode	yes
temperature drift	± 15 % (+10 ... +70 °C)
sensitivity adjustment	potentiometer, 12 turn
output indicator	LED yellow

electrical data

voltage supply range +Vs	10 ... 30 VDC
current consumption max. (no load)	20 mA
output current	< 200 mA
voltage drop Vd	< 1,5 VDC
switching frequency	< 50 Hz
short circuit protection	yes
reverse polarity protection	yes

mechanical data

type	cylindrical threaded
housing material	brass nickel plated
dimension	18 mm

ambient conditions

operating temperature	-25 ... +75 °C
protection class	IP 65

field of application

detection of non-conductive media	yes
fill level detection through container	yes
liquids in direct contact	no
object detection / bulk goods	yes

connectors and mating connectors

ESG 34SH0200	Connector M12, 3 pin, straight, 2 m
ESW 33SH0200	Connector M12, 3 pin, angular, 2 m

additional cable connectors and field wireable connectors: see accessories

Accessories

10151658	Sensofix series 18
10161958	Converter PNP/NPN - M12 x 1
11163237	Adapter for pulse stretching M12

for details: see accessories section

dimension drawings

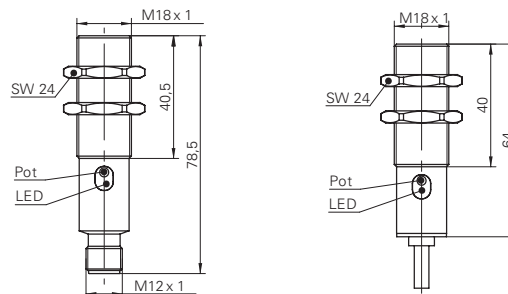

connection diagrams

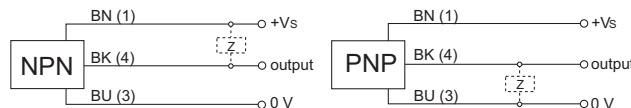

order reference	housing length	output circuit	connection types
CFAM 18N1600	64 mm	NPN make function (NO)	cable, 2 m
CFAM 18N1600/S14	78,5 mm	NPN make function (NO)	connector M12
CFAM 18N3600	64 mm	NPN break function (NC)	cable, 2 m
CFAM 18N3600/S14	78,5 mm	NPN break function (NC)	connector M12
CFAM 18P1600	64 mm	PNP make function (NO)	cable, 2 m
CFAM 18P1600/S14	78,5 mm	PNP make function (NO)	connector M12
CFAM 18P3600	64 mm	PNP break function (NC)	cable, 2 m
CFAM 18P3600/S14	78,5 mm	PNP break function (NC)	connector M12



Sn = 10 mm

- Smooth housing for installation with support bracket
- Sensitivity adjustment via pot
- Flush mounting possible

general data

nominal sensing distance Sn	10 mm
nominal sensing distance Sn adjustable	2 ... 10 mm
mounting type	flush
GND electrode	yes
temperature drift	± 15 % (+10 ... +70 °C)
sensitivity adjustment	potentiometer, 18 turn
output indicator	LED yellow

electrical data

voltage supply range +Vs	10 ... 30 VDC
current consumption max. (no load)	20 mA
output current	< 200 mA
voltage drop Vd	< 2,5 VDC
switching frequency	< 50 Hz
short circuit protection	yes
reverse polarity protection	yes

mechanical data

type	cylindrical smooth
housing material	brass nickel plated
dimension	20 mm
housing length	79,5 mm
connection types	cable, 2 m

ambient conditions

operating temperature	-25 ... +75 °C
protection class	IP 65

field of application

detection of non-conductive media	yes
fill level detection through container	yes
liquids in direct contact	no
object detection / bulk goods	yes

Accessories

10143377	Mounting bracket for sensors Ø 20 mm
for details: see accessories section	

order reference

order reference	output circuit
CFBM 20N1600	NPN make function (NO)
CFBM 20N3600	NPN break function (NC)
CFBM 20P1600	PNP make function (NO)
CFBM 20P3600	PNP break function (NC)



dimension drawing

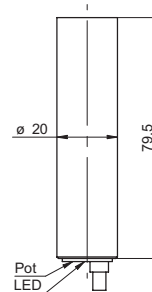

connection diagrams

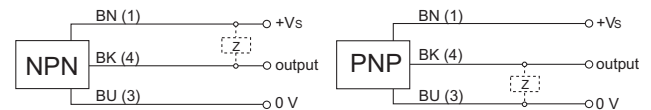

remarks

Mounting bracket included in delivery



Sn = 0,5 mm



- Level control of optimally conductive liquids
- Suitable for direct contact
- Suppression of dirt and drops

general data

special type	liquid level sensor for oil
mounting type	non-flush
version	adhesion resistant
measurement type	contact with medium
approvals/certificates	EN 60947-5-2 / EN 60947-5-7 EN ISO 14982:2009 ISO 15003:2006, Sec 5.13 ISO 13766:2006-05 EN 13309:2010

electrical data

voltage supply range +Vs	4,75 ... 5,25 VDC
current consumption max. (no load)	42 mA
current consumption typ.	10 mA
output circuit	voltage output
output state	in air 2,75 ... 3,25 V in liquid 1,25 ... 1,75 V fault 0,50 ... 1,00 V
typ. response time	< 1000 ms
load resistance	≥ 930 Ohm
capacitive load	< 200 nF
short circuit protection	yes
reverse polarity protection	no

mechanical data

type	cylindrical threaded
housing material	PA 10T/X
dimension	22 mm
housing length	87 mm
connection types	connector AMPSEAL 16 3 pin
tightening torque max.	14 Nm (min. 10 Nm)
fluid port	O-Ring port M22 x 1,5 (ISO 6149-1)

ambient conditions

operating temperature	-40 ... +85 °C
media temperature	-40 ... +100 °C
storage temperature	-55 ... +125 °C
protection class	IP 69K

field of application

detection of non-conductive media	no
fill level detection through container	no
liquids in direct contact	yes
object detection / bulk goods	no

order reference

CFAK 22U9500/AMP

dimension drawing

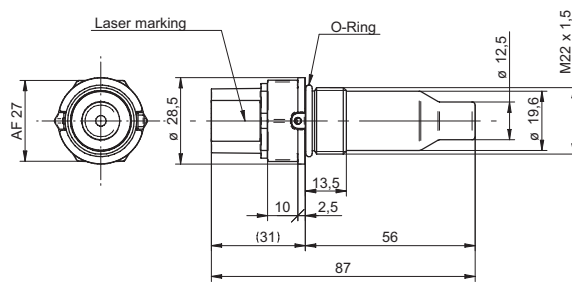

connection diagram

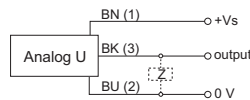

remarks

Other housing materials are available on request

CFAK 22 Sn = 0,5 mm

Capacitive proximity sensors



Sn = 8 mm

- Preset sensing distance
- Fully enclosed housing
- Direct contact with liquids possible



general data

nominal sensing distance Sn	8 mm
mounting type	non-flush
GND electrode	no
temperature drift	± 15 % (0 ... +70 °C)
sensitivity adjustment	no
output indicator	LED yellow

electrical data

voltage supply range +Vs	10 ... 30 VDC
current consumption max. (no load)	20 mA
output current	< 200 mA
voltage drop Vd	< 1,5 VDC
switching frequency	< 50 Hz
short circuit protection	yes
reverse polarity protection	yes

mechanical data

type	cylindrical threaded
housing material	PBT
dimension	30 mm
housing length	72 mm
connection types	cable, 2 m

ambient conditions

operating temperature	-25 ... +75 °C
protection class	IP 67/65 (sensing face/sensor)

field of application

detection of non-conductive media	yes
fill level detection through container	yes
liquids in direct contact	yes
object detection / bulk goods	yes

order reference

order reference	output circuit
CFAK 30N1100	NPN make function (NO)
CFAK 30N3100	NPN break function (NC)
CFAK 30P1100	PNP make function (NO)
CFAK 30P3100	PNP break function (NC)

dimension drawing

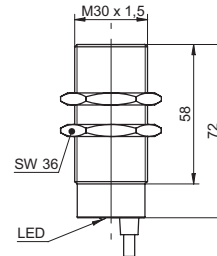

connection diagrams

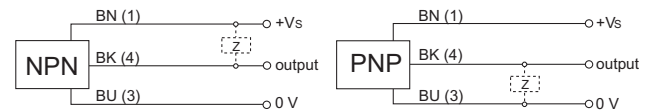

CFAK 30 Sn = 8 mm

Capacitive proximity sensors



Sn = 30 mm

- Sensitivity adjustment via pot
- Fully enclosed housing
- Direct contact with liquids possible



general data

nominal sensing distance Sn	30 mm
nominal sensing distance Sn adjustable	5 ... 30 mm
mounting type	non-flush
GND electrode	no
temperature drift	± 15 % (+10 ... +70 °C)
sensitivity adjustment	potentiometer, 18 turn
output indicator	LED yellow

electrical data

voltage supply range +Vs	10 ... 30 VDC
current consumption max. (no load)	20 mA
output current	< 200 mA
voltage drop Vd	< 1,5 VDC
switching frequency	< 50 Hz
short circuit protection	yes
reverse polarity protection	yes

mechanical data

type	cylindrical threaded
housing material	PBT
dimension	30 mm
housing length	72 mm
connection types	cable, 2 m

ambient conditions

operating temperature	-25 ... +75 °C
protection class	IP 67/65 (sensing face/sensor)

field of application

detection of non-conductive media	yes
fill level detection through container	yes
liquids in direct contact	yes
object detection / bulk goods	yes

dimension drawing

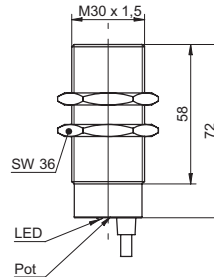

connection diagrams

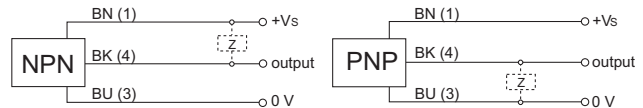

order reference **output circuit**

CFAK 30N1200	NPN make function (NO)
CFAK 30N3200	NPN break function (NC)
CFAK 30P1200	PNP make function (NO)
CFAK 30P3200	PNP break function (NC)



Sn = 15 mm

- Particularly suitable for non-conductive media
- Sensitivity adjustment via pot
- Flush mounting possible



general data

nominal sensing distance Sn	15 mm
nominal sensing distance Sn adjustable	4 ... 15 mm
mounting type	flush
GND electrode	yes
temperature drift	± 15 % (+10 ... +70 °C)
sensitivity adjustment	potentiometer, 18 turn
output indicator	LED yellow

electrical data

voltage supply range +Vs	10 ... 30 VDC
current consumption max. (no load)	20 mA
output current	< 200 mA
voltage drop Vd	< 1,5 VDC
switching frequency	< 50 Hz
short circuit protection	yes
reverse polarity protection	yes

mechanical data

type	cylindrical threaded
housing material	brass nickel plated
dimension	30 mm

ambient conditions

operating temperature	-25 ... +75 °C
protection class	IP 65

field of application

detection of non-conductive media	yes
fill level detection through container	yes
liquids in direct contact	no
object detection / bulk goods	yes

connectors and mating connectors

ESG 34SH0200	Connector M12, 3 pin, straight, 2 m
ESW 33SH0200	Connector M12, 3 pin, angular, 2 m
additional cable connectors and field wireable connectors: see accessories	

Accessories

10161958	Converter PNP/NPN - M12 x 1
11163237	Adapter for pulse stretching M12

for details: see accessories section

dimension drawings

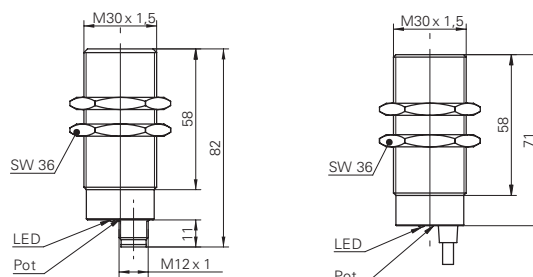

connection diagrams

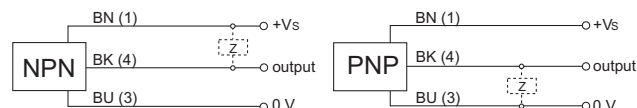

order reference	housing length	output circuit	connection types
CFAM 30N1600	71 mm	NPN make function (NO)	cable, 2 m
CFAM 30N1600/S14	82 mm	NPN make function (NO)	connector M12
CFAM 30N3600	71 mm	NPN break function (NC)	cable, 2 m
CFAM 30N3600/S14	82 mm	NPN break function (NC)	connector M12
CFAM 30P1600	71 mm	PNP make function (NO)	cable, 2 m
CFAM 30P1600/S14	82 mm	PNP make function (NO)	connector M12
CFAM 30P3600	71 mm	PNP break function (NC)	cable, 2 m
CFAM 30P3600/S14	82 mm	PNP break function (NC)	connector M12



Sn = 15 mm

- High temperature proof to +200 °C
- Resistent against a high number of chemicals
- Probe made of stainless steel & PTFE (anti-adherence)

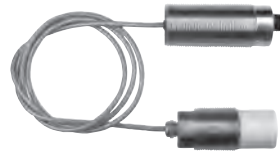

general data

special type	sensor for high temperatures
nominal sensing distance Sn	15 mm
nominal sensing distance Sn adjustable	4 ... 15 mm
mounting type	non-flush
GND electrode	no
temperature drift	± 16 %
sensitivity adjustment	potentiometer, 18 turn
output indicator	LED

electrical data

voltage supply range +Vs	10 ... 35 VDC
current consumption max. (no load)	15 mA
output current	< 200 mA
voltage drop Vd	< 2,5 VDC
switching frequency	< 50 Hz
short circuit protection	yes
reverse polarity protection	yes

mechanical data

type	cylindrical threaded
housing material	V2A/PTFE
dimension	30 mm
housing length	65 mm
connection types	connector M12

ambient conditions

operating temperature	-40 ... +200 °C
protection class	IP 67

field of application

detection of non-conductive media	yes
fill level detection through container	no
liquids in direct contact	yes
object detection / bulk goods	no

inline amplifier

operating temperature	-25 ... +75 °C
housing material	brass nickel plated
protection class	IP 65

connectors and mating connectors

ESG 34AH0200	Connector M12, 4 pin, straight, 2 m
ESW 33AH0200	Connector M12, 4 pin, angular, 2 m

additional cable connectors and field wireable connectors: see accessories

Accessories

10161958	Converter PNP/NPN - M12 x 1
11163237	Adapter for pulse stretching M12

for details: see accessories section

order reference output circuit

CFAH 30P1200/S14	PNP make function (NO)
CFAH 30P3200/S14	PNP break function (NC)

dimension drawing

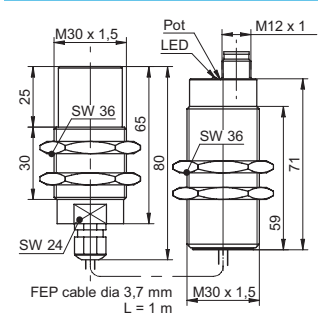

connection diagram

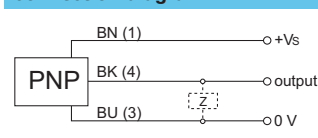

CFAH 30 Sn = 15 mm

Capacitive proximity sensors



Sn = 5 mm

- Preset sensing distance
- Compact, flat metal housing
- Flexible and easy installation options



general data

nominal sensing distance Sn	5 mm
mounting type	flush
GND electrode	yes
temperature drift	± 15 % (+10 ... +70 °C)
sensitivity adjustment	no
output indicator	4 port LED

electrical data

voltage supply range +Vs	10 ... 30 VDC
current consumption max. (no load)	20 mA
output current	< 200 mA
voltage drop Vd	< 1,5 VDC
switching frequency	< 50 Hz
short circuit protection	yes
reverse polarity protection	yes

mechanical data

type	rectangular
housing material	brass nickel plated
dimension	20 mm
housing length	35 mm
connection types	connector M8

ambient conditions

operating temperature	-25 ... +75 °C
protection class	IP 65

field of application

detection of non-conductive media	yes
fill level detection through container	yes
liquids in direct contact	no
object detection / bulk goods	yes

connectors and mating connectors

ESG 32SH0200	Connector M8, 3 pin, straight, 2 m
ESW 31SH0200	Connector M8, 3 pin, angular, 2 m

additional cable connectors and field wireable connectors: see accessories

Accessories

10152385	Sensofix series 18/20 inductive rectangular
10161959	Converter PNP/NPN - M8 x 1
11163236	Adapter for pulse stretching M8

for details: see accessories section

order reference output circuit

CFDM 20N1500/S35L	NPN make function (NO)
CFDM 20N3500/S35L	NPN break function (NC)
CFDM 20P1500/S35L	PNP make function (NO)
CFDM 20P3500/S35L	PNP break function (NC)

dimension drawing

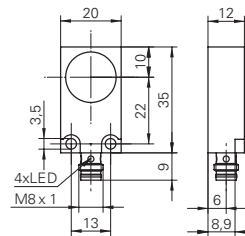

connection diagrams

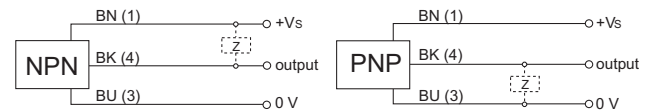

CFDM 20 Sn = 5 mm

Capacitive proximity sensors



Sn = 2 mm



- Particularly suitable for conductive liquids
- Extremely compact, flat housing
- Flexible installation options thanks to accessories

general data

nominal sensing distance Sn	2 mm
mounting type	flush
GND electrode	no
temperature drift	± 15 %
sensitivity adjustment	no
output indicator	LED red

electrical data

voltage supply range +Vs	10 ... 30 VDC
current consumption max. (no load)	15 mA
output circuit	push-pull
output current	< 100 mA
voltage drop Vd	< 3 VDC
switching frequency	< 35 Hz
short circuit protection	yes
reverse polarity protection	yes

mechanical data

type	rectangular
housing material	PA 12
dimension	25 mm
housing length	52,4 mm
depth	6 mm

ambient conditions

operating temperature	-25 ... +75 °C
protection class	IP 65

field of application

detection of non-conductive media	no
fill level detection through container	yes
liquids in direct contact	no
object detection / bulk goods	no

connectors and mating connectors

ESG 32SH0200	Connector M8, 3 pin, straight, 2 m
ESW 31SH0200	Connector M8, 3 pin, angular, 2 m

additional cable connectors and field wireable connectors: see accessories

Accessories

HC25-1	Mounting frame HC25-1 incl. accessories, optional Velcro strip order separately
BX 20-360-1	Velcro strip cut to length 360 mm

for details: see accessories section

dimension drawings

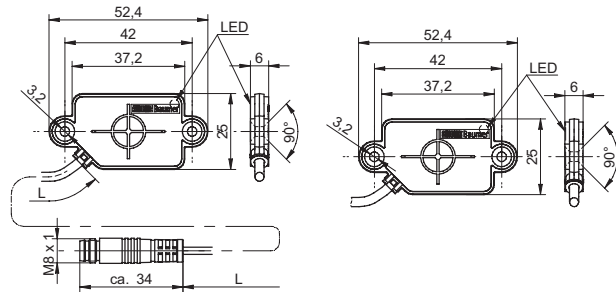

connection diagram

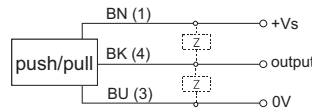

order reference	output function	connection types
CFDK 25G1125/KS35LN1	active high	flylead connector M8, L=200 mm
CFDK 25G1125/LN1	active high	cable PVC 3 x 0,14, 2 m
CFDK 25G3125/LN1	active low	cable PVC 3 x 0,14, 2 m

CFDK 25 Sn = 2 mm Capacitive proximity sensors



Sn = 4 mm

- Particularly suitable for conductive liquids
- Extremely compact, flat housing
- Flexible installation options thanks to accessories



general data

nominal sensing distance Sn	4 mm
mounting type	flush
GND electrode	no
temperature drift	± 15 %
sensitivity adjustment	no
output indicator	LED red

electrical data

voltage supply range +Vs	10 ... 30 VDC
current consumption max. (no load)	15 mA
output circuit	push-pull
output current	< 100 mA
voltage drop Vd	< 3 VDC
switching frequency	< 35 Hz
short circuit protection	yes
reverse polarity protection	yes

mechanical data

type	rectangular
housing material	PA 12
dimension	25 mm
housing length	52,4 mm
depth	6 mm

ambient conditions

operating temperature	-25 ... +75 °C
protection class	IP 65

field of application

detection of non-conductive media	no
fill level detection through container	yes
liquids in direct contact	no
object detection / bulk goods	no

connectors and mating connectors

ESG 32SH0200	Connector M8, 3 pin, straight, 2 m
ESW 31SH0200	Connector M8, 3 pin, angular, 2 m

additional cable connectors and field wireable connectors: see accessories

Accessories

HC25-1	Mounting frame HC25-1 incl. accessories, optional Velcro strip order separately
BX 20-360-1	Velcro strip cut to length 360 mm

for details: see accessories section

dimension drawings

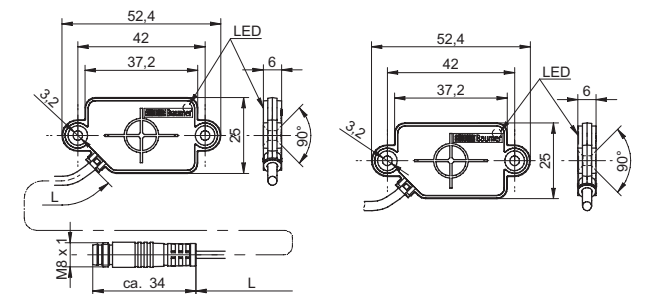

connection diagram

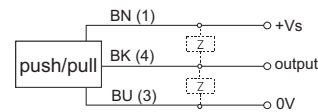

order reference	output function	connection types
CFDK 25G1125/KS35LN3	active high	flylead connector M8, L=200 mm
CFDK 25G1125/LN3	active high	cable PVC 3 x 0,14, 2 m
CFDK 25G3125/LN3	active low	cable PVC 3 x 0,14, 2 m

CFDK 25 Sn = 4 mm

Capacitive proximity sensors



Sn = 8 mm



- Suitable for liquids and objects
- Extremely compact, flat housing
- Flexible installation options thanks to accessories

general data

nominal sensing distance Sn	8 mm
mounting type	flush
GND electrode	no
temperature drift	± 20 %
sensitivity adjustment	no
output indicator	LED red

electrical data

voltage supply range +Vs	10 ... 30 VDC
current consumption max. (no load)	15 mA
output circuit	push-pull
output current	< 100 mA
voltage drop Vd	< 3 VDC
switching frequency	< 35 Hz
short circuit protection	yes
reverse polarity protection	yes

mechanical data

type	rectangular
housing material	PA 12
dimension	25 mm
housing length	52,4 mm
depth	6 mm

ambient conditions

operating temperature	-25 ... +75 °C
protection class	IP 65

field of application

detection of non-conductive media	yes
fill level detection through container	yes
liquids in direct contact	no
object detection / bulk goods	yes

connectors and mating connectors

ESG 32SH0200	Connector M8, 3 pin, straight, 2 m
ESW 31SH0200	Connector M8, 3 pin, angular, 2 m

additional cable connectors and field wireable connectors: see accessories

Accessories

HC25-1	Mounting frame HC25-1 incl. accessories, optional Velcro strip order separately
BX 20-360-1	Velcro strip cut to length 360 mm

for details: see accessories section

dimension drawings

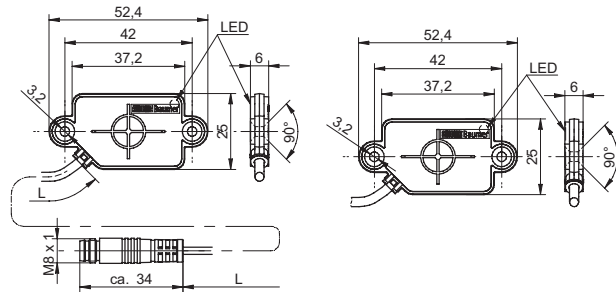

connection diagram

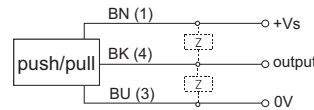

order reference	output function	connection types
CFDK 25G1125/KS35LN4	active high	flylead connector M8, L=200 mm
CFDK 25G1125/LN4	active high	cable PVC 3 x 0,14, 2 m
CFDK 25G3125/LN4	active low	cable PVC 3 x 0,14, 2 m



Sn = 12 mm

- Particularly suitable for non-conductive objects
- Extremely compact, flat housing
- Flexible installation options thanks to accessories



general data

nominal sensing distance Sn	12 mm
mounting type	flush
GND electrode	no
temperature drift	± 20 %
sensitivity adjustment	no
output indicator	LED red

electrical data

voltage supply range +Vs	10 ... 30 VDC
current consumption max. (no load)	15 mA
output circuit	push-pull
output current	< 100 mA
voltage drop Vd	< 3 VDC
switching frequency	< 35 Hz
short circuit protection	yes
reverse polarity protection	yes

mechanical data

type	rectangular
housing material	PA 12
dimension	25 mm
housing length	52,4 mm
depth	6 mm

ambient conditions

operating temperature	-25 ... +75 °C
protection class	IP 65

field of application

detection of non-conductive media	yes
fill level detection through container	no
liquids in direct contact	no
object detection / bulk goods	yes

connectors and mating connectors

ESG 32SH0200	Connector M8, 3 pin, straight, 2 m
ESW 31SH0200	Connector M8, 3 pin, angular, 2 m

additional cable connectors and field wireable connectors: see accessories

Accessories

HC25-1	Mounting frame HC25-1 incl. accessories, optional Velcro strip order separately
BX 20-360-1	Velcro strip cut to length 360 mm

for details: see accessories section

dimension drawings

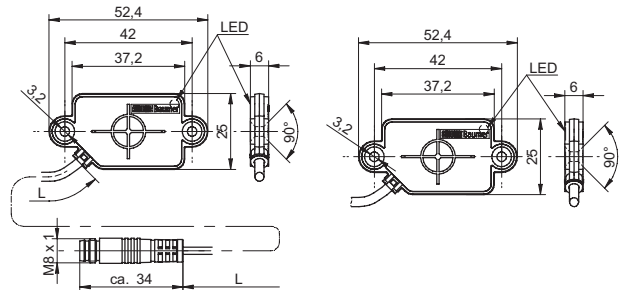

connection diagram

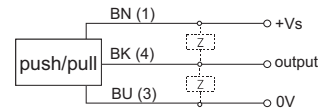

order reference	output function	connection types
CFDK 25G1125/KS35LN5	active high	flylead connector M8, L=200 mm
CFDK 25G1125/LN5	active high	cable PVC 3 x 0,14, 2 m
CFDK 25G3125/LN5	active low	cable PVC 3 x 0,14, 2 m

CFDK 25 Sn = 12 mm

Capacitive proximity sensors



Sn = 15 mm



- Particularly suitable for non-conductive objects
- Extremely compact, flat housing
- Flexible installation options thanks to accessories

general data

nominal sensing distance Sn	15 mm
mounting type	non-flush
GND electrode	no
temperature drift	± 20 % (0 ... +75 °C) ± 30 % (-25 ... 0 °C)
sensitivity adjustment	no
output indicator	LED red

electrical data

voltage supply range +Vs	10 ... 30 VDC
current consumption max. (no load)	15 mA
output circuit	push-pull
output current	< 100 mA
voltage drop Vd	< 3 VDC
switching frequency	< 35 Hz
short circuit protection	yes
reverse polarity protection	yes

mechanical data

type	rectangular
housing material	PA 12
dimension	25 mm
housing length	52,4 mm
depth	6 mm

ambient conditions

operating temperature	-25 ... +75 °C
protection class	IP 65

field of application

detection of non-conductive media	yes
fill level detection through container	no
liquids in direct contact	no
object detection / bulk goods	yes

connectors and mating connectors

ESG 32SH0200	Connector M8, 3 pin, straight, 2 m
ESW 31SH0200	Connector M8, 3 pin, angular, 2 m

additional cable connectors and field wireable connectors: see accessories

Accessories

HC25-1	Mounting frame HC25-1 incl. accessories, optional Velcro strip order separately
BX 20-360-1	Velcro strip cut to length 360 mm

for details: see accessories section

dimension drawings

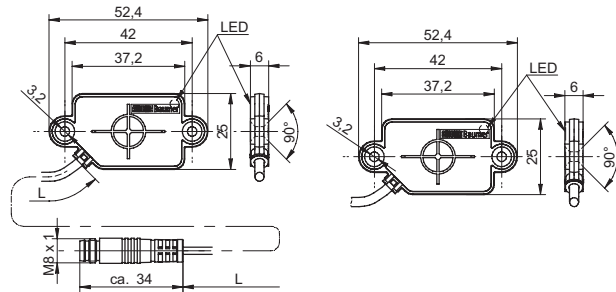

connection diagram

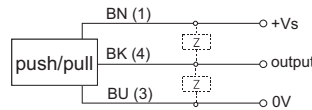

order reference	output function	connection types
CFDK 25G1125/KS35LN6	active high	flylead connector M8, L=200 mm
CFDK 25G1125/LN6	active high	cable PVC 3 x 0,14, 2 m
CFDK 25G3125/LN6	active low	cable PVC 3 x 0,14, 2 m



Sn = 15 mm

- Sensitivity adjustment via pot
- Rectangular housing
- Flush mounting possible

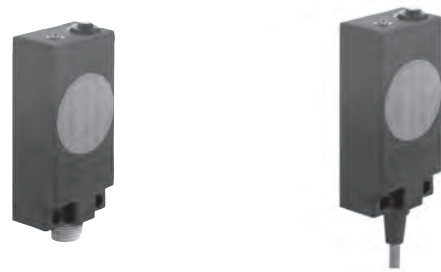

general data

nominal sensing distance Sn	15 mm
nominal sensing distance Sn adjustable	4 ... 15 mm
mounting type	flush
GND electrode	yes
temperature drift	± 15 % (+10 ... +70 °C)
sensitivity adjustment	potentiometer, 15 turn
output indicator	LED yellow

electrical data

voltage supply range +Vs	10 ... 30 VDC
current consumption max. (no load)	20 mA
output current	< 200 mA
voltage drop Vd	< 1,5 VDC
switching frequency	< 50 Hz
short circuit protection	yes
reverse polarity protection	yes

mechanical data

type	rectangular
housing material	PBT
dimension	30 mm

ambient conditions

operating temperature	-25 ... +75 °C
protection class	IP 65

field of application

detection of non-conductive media	yes
fill level detection through container	yes
liquids in direct contact	no
object detection / bulk goods	yes

connectors and mating connectors

ESG 34SH0200	Connector M12, 3 pin, straight, 2 m
ESW 33SH0200	Connector M12, 3 pin, angular, 2 m

additional cable connectors and field wireable connectors: see accessories

Accessories

10152386	Sensofix series 30
10161958	Converter PNP/NPN - M12 x 1
11163237	Adapter for pulse stretching M12

for details: see accessories section

dimension drawings

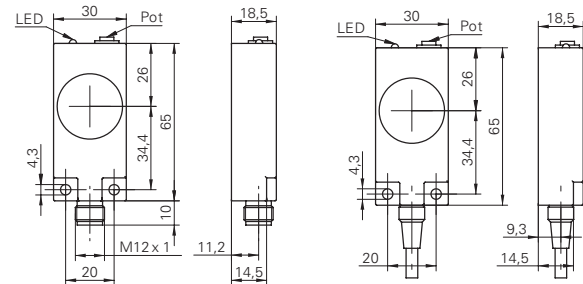

connection diagrams

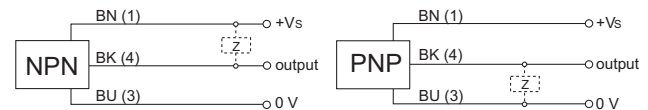

order reference	housing length	output circuit	connection types
CFDK 30N1600	65 mm	NPN make function (NO)	cable, 2 m
CFDK 30N1600/S14	75 mm	NPN make function (NO)	connector M12
CFDK 30N3600	65 mm	NPN break function (NC)	cable, 2 m
CFDK 30N3600/S14	75 mm	NPN break function (NC)	connector M12
CFDK 30P1600	65 mm	PNP make function (NO)	cable, 2 m
CFDK 30P1600/S14	75 mm	PNP make function (NO)	connector M12
CFDK 30P3600	65 mm	PNP break function (NC)	cable, 2 m
CFDK 30P3600/S14	75 mm	PNP break function (NC)	connector M12

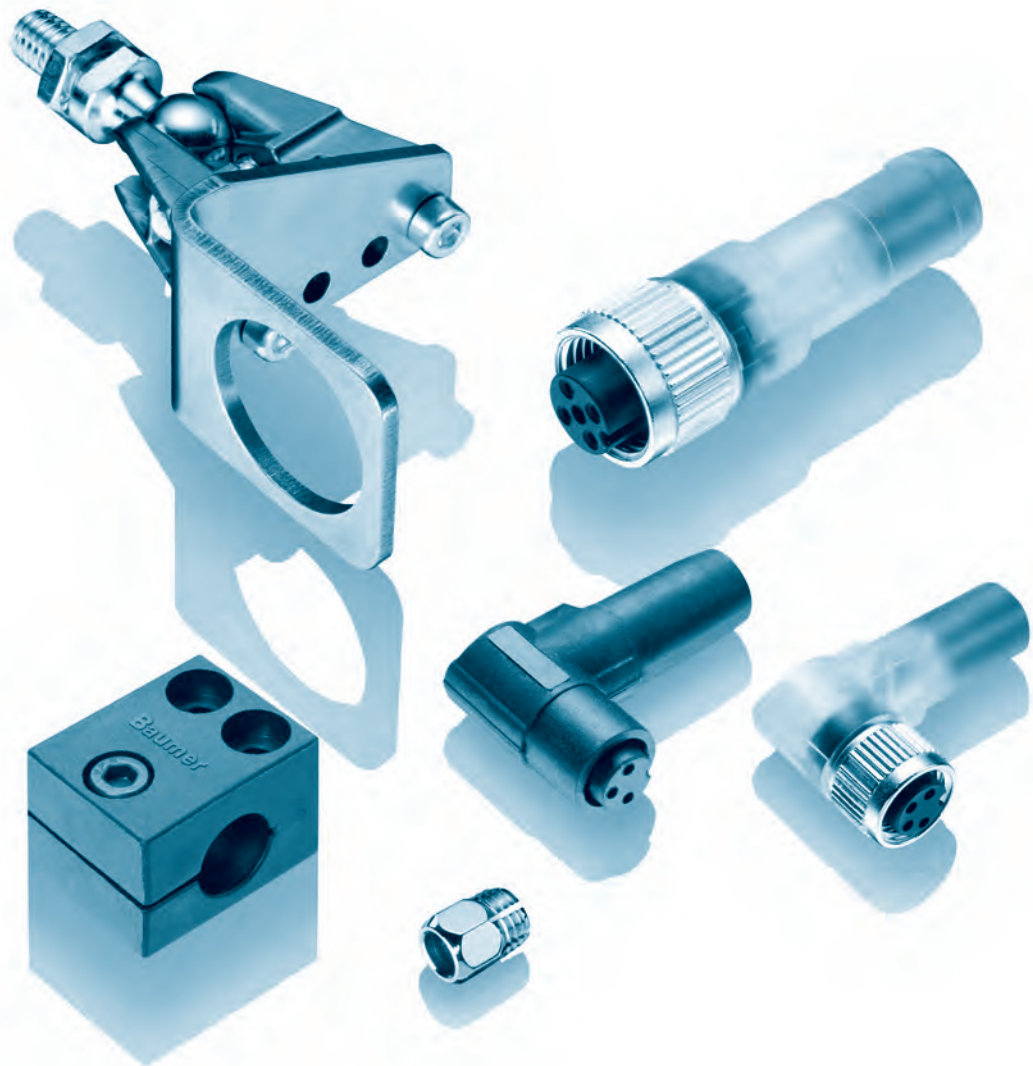

Accessories

Connectors and mating connectors	Page 42
Connectors / Pin assignment	Page 46
Connectors / Housing types	Page 47
Mounting accessories	Page 48
Mounting accessories Sensofix	Page 50
Mounting accessories CFDK 25	Page 51

ES 18 - Cable socket M12 straight, not pre-assembled

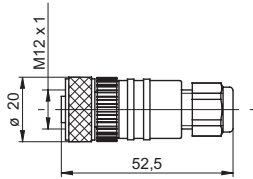

order reference	
ES 18A PG7	Connector M12, 4 pin, straight
ES 18C PG7	Connector M12, 5 pin, straight

- Connector female unshielded
- Connector only, no cable supplied
- 4 and 5 pin versions

ES 14 - Cable socket M12 angular, not pre-assembled

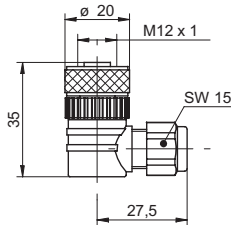

order reference	
ES 14A PG7	Connector M12, 4 pin, angular
ES 14C PG7	Connector M12, 5 pin, angular

- Connector female unshielded
- Connector only, no cable supplied
- 4 and 5 pin versions

ES 21 - Cable socket M8 straight, not pre-assembled

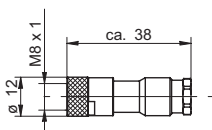

order reference	
ES 21	Connector M8, 3 pin, straight
ES 21A	Connector M8, 4 pin, straight

- Connector female unshielded
- Connector only, no cable supplied
- 3 and 4 pin version

ES 22 - Cable socket M8 angular, not pre-assembled

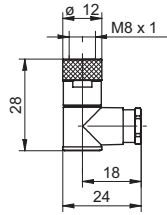

- Connector female unshielded
- Connector only, no cable supplied
- 3 and 4 pin versions

order reference

ES 22	Connector M8, 3 pin, angular
ES 22A	Connector M8, 4 pin, angular

ESG 32 - Connector M8 straight

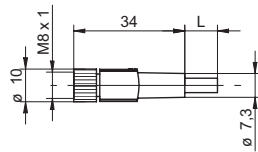

- Connector unshielded
- 3 and 4 pin versions
- Cable coating PUR
- Halogen-free
- Suitable for flexible cable carriers
- UL listed, number E315836
- Meet EN 60079-25 requirements for intrinsically safe ATEX applications

order reference

ESG 32AH0200	Connector M8, 4 pin, straight, 2 m
ESG 32AH0500	Connector M8, 4 pin, straight, 5 m
ESG 32AH1000	Connector M8, 4 pin, straight, 10 m
ESG 32SH0200	Connector M8, 3 pin, straight, 2 m
ESG 32SH0500	Connector M8, 3 pin, straight, 5 m
ESG 32SH0500/PL	Connector M8, 3 pin, straight, 5 m
ESG 32SH1000	Connector M8, 3 pin, straight, 10 m

ESG 32G - Connector M8 straight, shielded

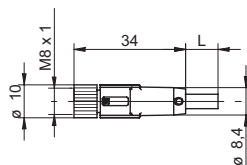

- Connector shielded, screen connected with cap nut
- 3 and 4 pin versions
- Cable coating PUR
- Halogen-free
- Suitable for flexible cable carriers
- UL listed, number E315836

order reference

ESG 32AH0200G	Connector M8, 4 pin, straight, 2 m, shielded
ESG 32AH0500G	Connector M8, 4 pin, straight, 5 m, shielded
ESG 32AH1000G	Connector M8, 4 pin, straight, 10 m, shielded
ESG 32SH0500G	Connector M8, 3 pin, straight, 5 m, shielded
ESG 32SH1000G/T	Connector M8, 3 pin, straight, 10 m, shielded

ESW 31 - Connector M8 angular

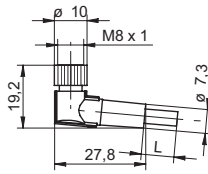

- Connector unshielded
- 3 and 4 pin versions
- Cable coating PUR
- Halogen-free
- Suitable for flexible cable carriers
- UL listed, number E315836
- Meet EN 60079-25 requirements for intrinsically safe ATEX applications

order reference	
ESW 31AH0200	Connector M8, 4 pin, angular, 2 m
ESW 31AH0500	Connector M8, 4 pin, angular, 5 m
ESW 31AH1000	Connector M8, 4 pin, angular, 10 m
ESW 31SH0200	Connector M8, 3 pin, angular, 2 m
ESW 31SH0500	Connector M8, 3 pin, angular, 5 m
ESW 31SH0500/PL	Connector M8, 3 pin, angular, 5 m
ESW 31SH1000	Connector M8, 3 pin, angular, 10 m

ESW 31G - Connector M8 angular, shielded

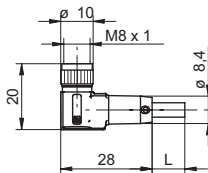

- Connector shielded, screen connected with cap nut
- 3 and 4 pin versions
- Cable coating PUR
- Halogen-free
- Suitable for flexible cable carriers
- UL listed, number E315836

order reference	
ESW 31AH0200G	Connector M8, 4 pin, angular, 2 m, shielded
ESW 31AH0500G	Connector M8, 4 pin, angular, 5 m, shielded
ESW 31AH1000G	Connector M8, 4 pin, angular, 10 m, shielded
ESW 31SH0200G	Connector M8, 3 pin, angular, 2 m, shielded
ESW 31SH0500G	Connector M8, 3 pin, angular, 5 m, shielded

ESG 34 - Connector M12 straight

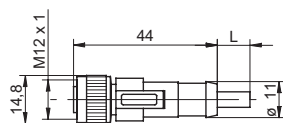

- Connector unshielded
- 3, 4 and 5 pin versions
- Cable coating PUR
- Halogen-free
- Suitable for flexible cable carriers
- UL listed, number E315836

order reference	
ESG 34AH0200	Connector M12, 4 pin, straight, 2 m
ESG 34AH0500	Connector M12, 4 pin, straight, 5 m
ESG 34AH1000	Connector M12, 4 pin, straight, 10 m
ESG 34CH0200	Connector M12, 5 pin, straight, 2 m
ESG 34CH0500	Connector M12, 5 pin, straight, 5 m
ESG 34SH0200	Connector M12, 3 pin, straight, 2 m
ESG 34SH0500	Connector M12, 3 pin, straight, 5 m
ESG 34SH1000	Connector M12, 3 pin, straight, 10 m

ESG 34G - Connector M12 straight, shielded

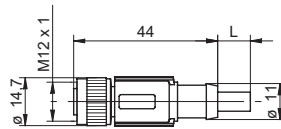

- Connector shielded, screen connected with cap nut
- 4, 5 and 8 pin versions
- Cable coating PUR
- Halogen-free
- Suitable for flexible cable carriers
- UL listed, number E315836

order reference	
ESG 34AH0200G	Connector M12, 4 pin, straight, 2 m, shielded
ESG 34AH0500G	Connector M12, 4 pin, straight, 5 m, shielded
ESG 34AH1000G	Connector M12, 4 pin, straight, 10 m, shielded
ESG 34CH0200G	Connector M12, 5 pin, straight, 2 m, shielded
ESG 34CH0500G	Connector M12, 5 pin, straight, 5 m, shielded
ESG 34CH1000G	Connector M12, 5 pin, straight, 10 m, shielded
ESG 34FH0200G	Connector M12, 8 pin, straight, 2 m, shielded
ESG 34FH0500G	Connector M12, 8 pin, straight, 5 m, shielded
ESG 34FH1000G	Connector M12, 8 pin, straight, 10 m, shielded

ESW 33 - Connector M12 angular

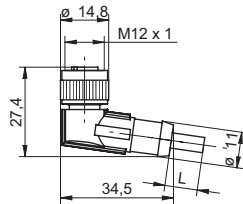

- Connector unshielded
- 3, 4 and 5 pin versions
- Cable coating PUR
- Halogen-free
- Suitable for flexible cable carriers
- UL listed, number E315836

order reference	
ESW 33AH0200	Connector M12, 4 pin, angular, 2 m
ESW 33AH0500	Connector M12, 4 pin, angular, 5 m
ESW 33AH1000	Connector M12, 4 pin, angular, 10 m
ESW 33CH0200	Connector M12, 5 pin, angular, 2 m
ESW 33CH0500	Connector M12, 5 pin, angular, 5 m
ESW 33SH0200	Connector M12, 3 pin, angular, 2 m
ESW 33SH0500	Connector M12, 3 pin, angular, 5 m
ESW 33SH1000	Connector M12, 3 pin, angular, 10 m

ESW 33G - Connector M12 angular, shielded

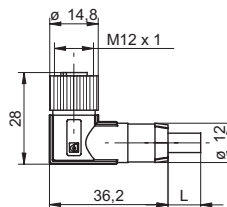

- Connector shielded, screen connected with cap nut
- 4, 5 and 8 pin versions
- Cable coating PUR
- Halogen-free
- Suitable for flexible cable carriers
- UL listed, number E315836

order reference	
ESW 33AH0200G	Connector M12, 4 pin, angular, 2 m, shielded
ESW 33AH0500G	Connector M12, 4 pin, angular, 5 m, shielded
ESW 33AH1000G	Connector M12, 4 pin, angular, 10 m, shielded
ESW 33CH0500G	Connector M12, 5 pin, angular, 5 m, shielded
ESW 33FH0200G	Connector M12, 8 pin, angular, 2 m, shielded
ESW 33FH0500G	Connector M12, 8 pin, angular, 5 m, shielded
ESW 33FH1000G	Connector M12, 8 pin, angular, 10 m, shielded

M8 3 pin

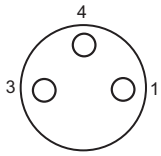

- 1 = BN
- 3 = BU
- 4 = BK

M8 4 pin

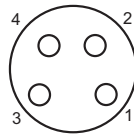

- 1 = BN
- 2 = WH
- 3 = BU
- 4 = BK

ES 21
ES 22
ESG 32S
ESW 31S

ES 21A
ES 22A
ESG 32A
ESW 31A

M12 3 pin

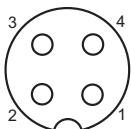

- 1 = BN
- 2 = n.c.
- 3 = BU
- 4 = BK

M12 4 pin

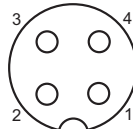

- 1 = BN
- 2 = WH
- 3 = BU
- 4 = BK

M12 5 pin

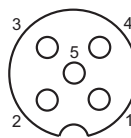

- 1 = BN
- 2 = WH
- 3 = BU
- 4 = BK
- 5 = GY

8 pin

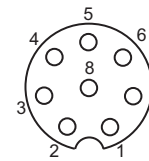

- 1 = WH
- 2 = BN
- 3 = GN
- 4 = YE
- 5 = GY
- 6 = PK
- 7 = BU
- 8 = RD

ESG 34S
ESW 33S

ES 14
ES 18
ES 21C
ES 22C
ESG 34A
ESW 33A

ES 14C
ES 18C
ESG 34C
ESW 33C

ESG 34G
ESW 33G

Connectors M8

Dimension	20	Dimension	20
-----------	----	-----------	----

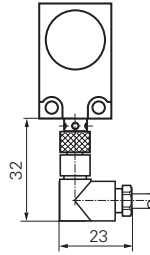
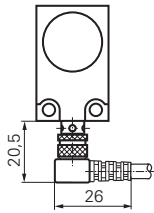

Connectors M12

Dimension	30	Dimension	30
-----------	----	-----------	----

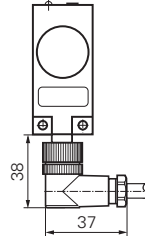
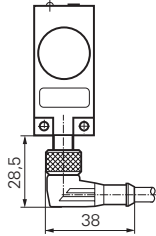

Test unit for sensors analog & digital



- Output via display (V or mA) or LED (PNP/NPN)
- Teach-in of sensors with integrated Teach- button
- Connection for plug in power supply (available as accessory)

Test- and configuration device for analog and digital PNP/NPN sensors with 18 VDC supply voltage

order reference
11084376 Test unit for sensors analog & digital

Test unit for sensors digital



- LED (red/green) for digital PNP/NPN signals
- Teach-in of sensors with integrated Teach- button
- Connection for plug in power supply (available as accessory)

Test- and configuration device for digital PNP/NPN sensors with 18 VDC supply voltage

order reference
11084377 Test unit for sensors digital

Power supply for sensor test unit



- Input 90-260 VAC
- Output 24 V/0,75 A
- Interchangeable plug-Type A, C, G and I

Protects the batteries of the sensor tester analog & digital for extended lifetime

order reference
11087165 Test unit for sensors

PNP to NPN Converter M8

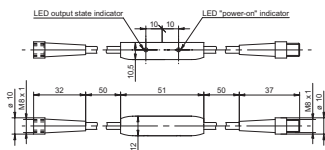

- PNP/NPN Converter
- For frequencies up to max. 5 kHz
- For connector M8 - 3 pins

order reference
10161959 Converter PNP/NPN - M8 x 1

PNP to NPN Converter M12

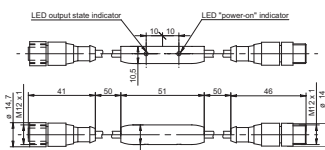

- PNP/NPN Converter
- For frequencies up to max. 5 kHz
- For connector M12 - 3 pins

order reference
10161958 Converter PNP/NPN - M12 x 1

PNP pulse converter M8

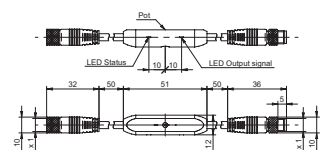

- Adapter for pulse stretching
- For pulse stretching 1 ... 150 ms
- For connector M8 - 3 pins

order reference
11163236 Adapter for pulse stretching M8

PNP pulse converter M12

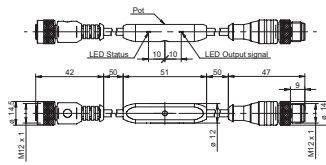

- Adapter for pulse stretching
- For pulse stretching 1 ... 150 ms
- For connector M12 - 3 pins

order reference

11163237 Adapter for pulse stretching M12

Sensofix-Mounting kit for sensors series 12 round

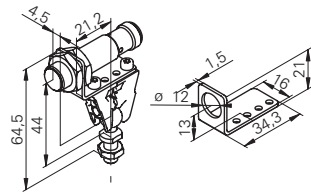

- Clamps made of stainless steel
- Ball pivots made of galvanized steel
- Mounting panel made of stainless steel

For use with all sensors in M12 housing

order reference

10151720 Sensofix series 12 round

Sensofix-Mounting kit for sensors series 18 round

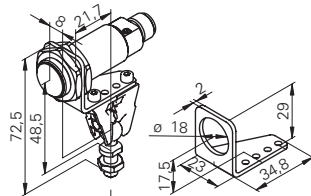

- Clamps made of stainless steel
- Ball pivots made of galvanized steel
- Mounting panel made of stainless steel

For use with all sensors in M18 housing

order reference

10151658 Sensofix series 18

Sensofix-Mounting kit for sensors series 18/20

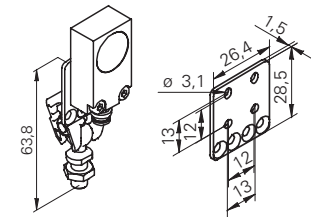

- Clamps made of stainless steel
- Ball pivots made of galvanized steel
- Mounting panel made of stainless steel

For use with inductive sensors series 18/20 in rectangular designs

order reference

10152385 Sensofix series 18/20 inductive rectangular

Mounting bracket 20 mm

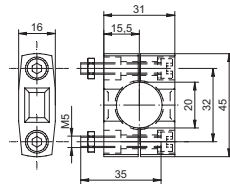

- Material: Polypropylene (PP)

For sensors with Ø 20 mm

order reference

10143377 Mounting bracket for sensors Ø 20 mm

Mounting kit for CFDK 25

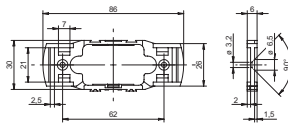
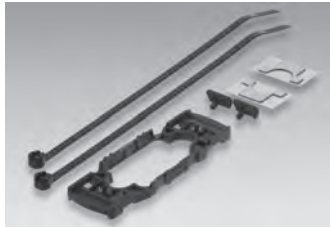

order reference	
HC25-1	Mounting frame HC25-1 incl. accessories, optional Velcro strip order separately

- 1 pcs. mounting frame HC25; Material PA 12
- 2 pcs. cable ties 186x4,7 mm
- 2 pcs. adhesive pads
- 2 pcs. spacer

For use with CFDK 25

Velcro strip cut to length for mounting frame HC25

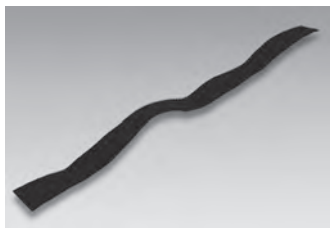

order reference	
BX 20-1200-1	Velcro strip cut to length 1200 mm
BX 20-2000-1	Velcro strip cut to length 2000 mm
BX 20-360-1	Velcro strip cut to length 360 mm
BX 20-4000-1	Velcro strip cut to length 4000 mm

- Base material: Polyamide
- Overall thickness: 1,8 to 2,2 mm
- Breaking strength: > 210 N/cm

For use with mounting frame HC25

Snap-in without tools

1. Fasten frame

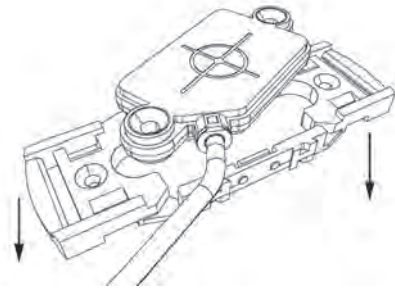

2. Snap in sensor

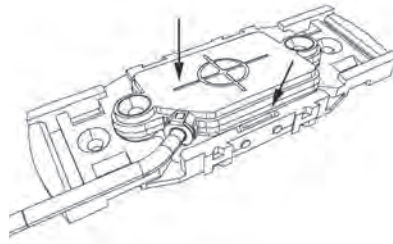

3. Done

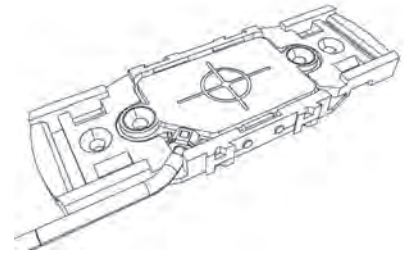

Installation options

Flush with countersunk screws

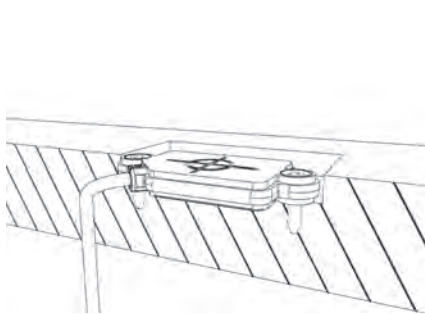

With cable ties

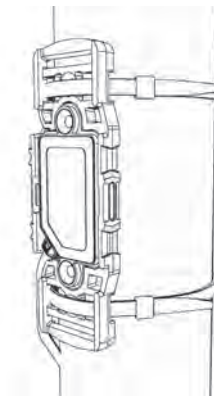

With Velcro

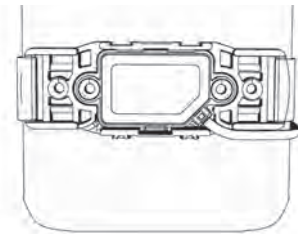

Cascaded installation

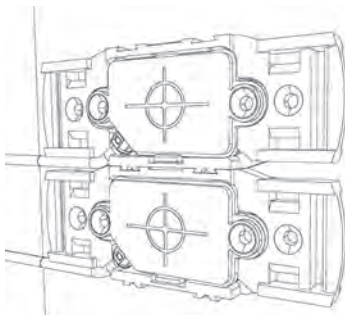

Fixing with glue or adhesive pads

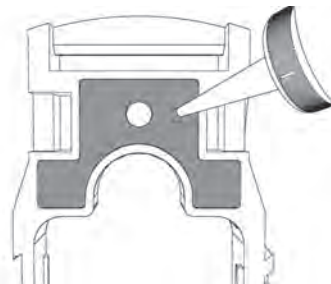

With countersunk screws

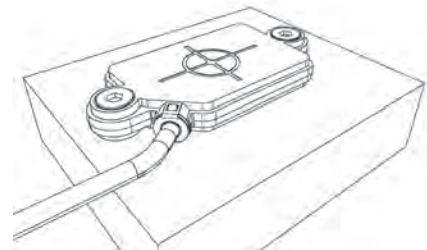

order reference	page
1	
10143377	50
10151658	50
10151720	50
10152385	50
10161958	48
10161959	48
11084376	48
11084377	48
11087165	48
11163236	48
11163237	49
B	
BX 20-1200-1	51
BX 20-2000-1	51
BX 20-360-1	51
BX 20-4000-1	51
C	
CFAH 30P1200/S14	32
CFAH 30P3200/S14	32
CFAK 12N1103	22
CFAK 12N1140/KS35L	21
CFAK 12N1140/L	21
CFAK 12N3103	22
CFAK 12N3140/KS35L	21
CFAK 12N3140/L	21
CFAK 12P1103	22
CFAK 12P1140/KS35L	21
CFAK 12P1140/L	21
CFAK 12P3103	22
CFAK 12P3140/KS35L	21
CFAK 12P3140/L	21
CFAK 18N1100	24
CFAK 18N1200	25
CFAK 18N3100	24
CFAK 18N3200	25
CFAK 18P1100	24
CFAK 18P1200	25
CFAK 18P3100	24
CFAK 18P3200	25
CFAK 22U9500/AMP	28
CFAK 30N1100	29
CFAK 30N1200	30
CFAK 30N3100	29
CFAK 30N3200	30
CFAK 30P1100	29
CFAK 30P1200	30
CFAK 30P3100	29
CFAK 30P3200	30
CFAM 12N1600	23
CFAM 12N1600/S14	23
CFAM 12N3600	23
CFAM 12N3600/S14	23
CFAM 12P1600	23
CFAM 12P1600/S14	23

order reference	page
CFAM 12P3600	23
CFAM 12P3600/S14	23
CFAM 18N1600	26
CFAM 18N1600/S14	26
CFAM 18N3600	26
CFAM 18N3600/S14	26
CFAM 18P1600	26
CFAM 18P1600/S14	26
CFAM 18P3600	26
CFAM 18P3600/S14	26
CFAM 30N1600	31
CFAM 30N1600/S14	31
CFAM 30N3600	31
CFAM 30N3600/S14	31
CFAM 30P1600	31
CFAM 30P1600/S14	31
CFAM 30P3600	31
CFAM 30P3600/S14	31
CFBM 20N1600	27
CFBM 20N3600	27
CFBM 20P1600	27
CFBM 20P3600	27
CFDK 25G1125/KS35LN1	34
CFDK 25G1125/KS35LN3	35
CFDK 25G1125/KS35LN4	36
CFDK 25G1125/KS35LN5	37
CFDK 25G1125/KS35LN6	38
CFDK 25G1125/LN1	34
CFDK 25G1125/LN3	35
CFDK 25G1125/LN4	36
CFDK 25G1125/LN5	37
CFDK 25G1125/LN6	38
CFDK 25G3125/LN1	34
CFDK 25G3125/LN3	35
CFDK 25G3125/LN4	36
CFDK 25G3125/LN5	37
CFDK 25G3125/LN6	38
CFDK 30N1600	39
CFDK 30N1600/S14	39
CFDK 30N3600	39
CFDK 30N3600/S14	39
CFDK 30P1600	39
CFDK 30P1600/S14	39
CFDK 30P3600	39
CFDK 30P3600/S14	39
CFDM 20N1500/S35L	33
CFDM 20N3500/S35L	33
CFDM 20P1500/S35L	33
CFDM 20P3500/S35L	33
E	
ES 14A PG7	42
ES 14C PG7	42
ES 18A PG7	42
ES 18C PG7	42
ES 21	42
ES 21A	42
ES 22	43
ES 22A	43

order reference	page
ESG 32AH0200	43, 46
ESG 32AH0200G	43
ESG 32AH0500	43, 46
ESG 32AH0500G	43
ESG 32AH1000	43, 46
ESG 32AH1000G	43
ESG 32SH0200	43, 46
ESG 32SH0500	43, 46
ESG 32SH0500/PL	43
ESG 32SH0500G	43
ESG 32SH1000	43, 46
ESG 32SH1000G/T	43
ESG 34AH0200	44
ESG 34AH0200G	45
ESG 34AH0500	44
ESG 34AH0500G	45
ESG 34AH1000	44
ESG 34AH1000G	45
ESG 34CH0200	44
ESG 34CH0200G	45
ESG 34CH0500	44
ESG 34CH0500G	45
ESG 34CH1000G	45
ESG 34FH0200G	45
ESG 34FH0500G	45
ESG 34FH1000G	45
ESG 34SH0200	44
ESG 34SH0500	44
ESG 34SH1000	44
ESW 31AH0200	44
ESW 31AH0200G	44
ESW 31AH0500	44
ESW 31AH0500G	44
ESW 31AH1000	44
ESW 31AH1000G	44
ESW 31SH0200	44
ESW 31SH0200G	44
ESW 31SH0500	44
ESW 31SH0500/PL	44
ESW 31SH0500G	44
ESW 31SH1000	44
ESW 33AH0200	45
ESW 33AH0200G	45
ESW 33AH0500	45
ESW 33AH0500G	45
ESW 33AH1000	45
ESW 33AH1000G	45
ESW 33CH0200	45
ESW 33CH0500	45
ESW 33CH0500G	45
ESW 33FH0200G	45
ESW 33FH0500G	45
ESW 33FH1000G	45
ESW 33SH0200	45
ESW 33SH0500	45
ESW 33SH1000	45
H	
HC25-1	51

Baumer – the strong partner.

We at Baumer are close to our customers, understand their needs and provide the best solution. Worldwide customer service for Baumer starts with on-the-spot personal discussions and qualified consultation. Our application engineers speak your language and strive from the start, through an interactive problem analysis, to offer comprehensive and user-compatible solutions.

We are close to you across the globe.

The worldwide Baumer sales organizations guarantee short delivery times and readiness to supply. Many of our customers are directly linked via our electronic order system with the JIT logistics process.

A worldwide network coupled with the most modern communication techniques enable us to deliver information quickly and transparently to decision makers in all Baumer locations.

Closeness to the customer for Baumer means being available for your needs anywhere and at any time.



Worldwide presence.



Africa

Algeria
Cameroon
Côte d'Ivoire
Egypt
Morocco
Reunion
South Africa

America

Brazil
Canada
Colombia
Mexico
United States
Venezuela

Asia

Bahrain
China
India
Indonesia
Israel
Japan
Kuwait
Malaysia
Oman
Philippines
Qatar
Saudi Arabia
Singapore
South Korea
Taiwan
Thailand
UAE

Europe

Austria
Belgium
Bulgaria
Croatia
Czech Republic
Denmark
Finland
France
Germany
Greece
Hungary
Italy
Malta
Martinique
Netherlands
Norway
Poland
Portugal
Romania
Russia
Serbia
Slovakia
Slovenia
Spain
Sweden
Switzerland
Turkey
United Kingdom

Oceania

Australia
New Zealand



For more information
about our worldwide
locations go to:
www.baumer.com/worldwide

Our overall portfolio

Baumer provides for every application the perfect solution.

Presence detection

- Inductive sensors
- Photoelectric sensors
- Ultrasonic sensors
- Capacitive sensors
- Magnetic sensors
- Mechanical precision switches

Distance measurement

- Inductive sensors
- Photoelectric sensors
- Ultrasonic sensors
- Bearingless linear encoders
- Cable-pull encoders

Rotary encoders / Angle measurement

- Absolute encoders
- Incremental encoders
- HeavyDuty encoders
- Bearingless encoders
- Format alignment
- Inclination sensors

Identification / Image processing

- Industrial Cameras
- Vision Sensors

Process instrumentation

- Level measurement
- Temperature measurement
- Pressure measurement
- Conductivity measurement
- Force/strain sensors
- Counters
- Process displays



Baumer Group
International Sales
P.O. Box · Hummelstrasse 17 · CH-8501 Frauenfeld
Phone +41 52 728 1122 · Fax +41 52 728 1144
sales@baumer.com · www.baumer.com

Represented by: